

TRITEC

ENERGY FOR A BETTER WORLD

TRI-STAND

The smart insertion system for PV systems on corrugated fibre cement.

- simple
- quick
- efficient

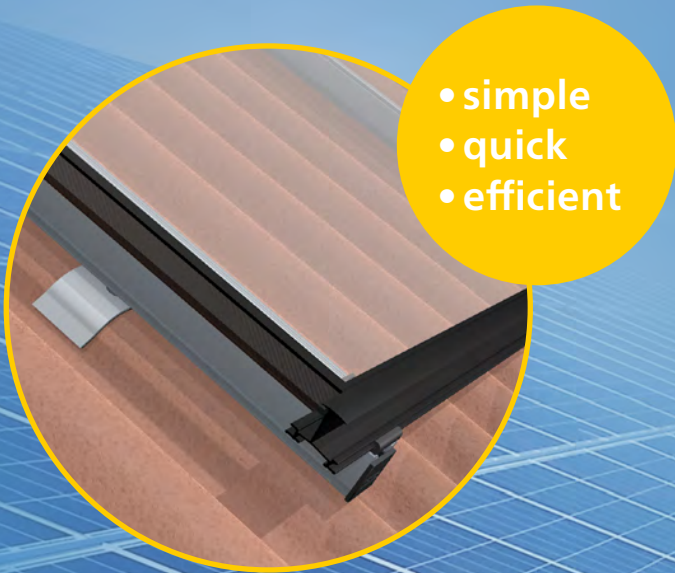

The main advantages:

- Floating rooftop system, therefore no thermal separation necessary
- No stresses on the module or rail system due to thermal expansion
- Simple, quick and efficient installation
- Optimum load distribution and stability
- Suitable for all common framed solar modules

www.tritec-energy.com

TRI-STAND FOR CORRUGATED FIBRE CEMENT

This way you easily increase your efficiency

Realize your projects in an unbeatably short time: The smart planning software, the few components and the patented SafeClick assembly enable an extremely quick, safe and simple installation of the PV insertion system TRI-STAND on the roof. The PV modules are easily inserted into the insertion profiles and are held in place by their own weight. Additional fastening of the modules is completely unnecessary.

TRI-STAND is installed in just a few steps



1. Mounting the TS-COR

First, mount the TS-COR at the locations provided in the design plan using the existing roof screws¹.

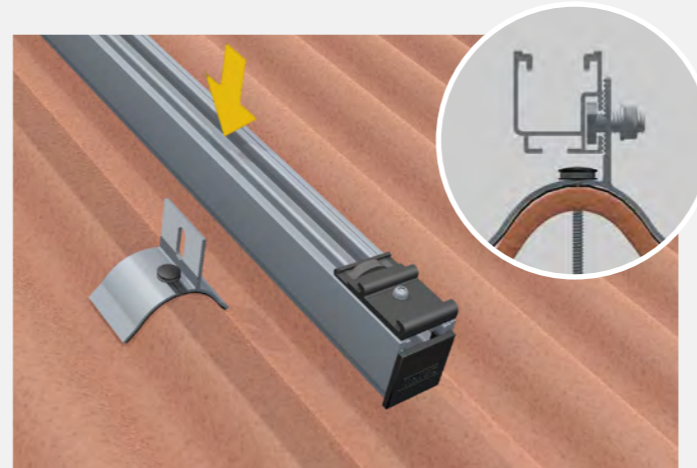

2. Mounting the base profile (UP-X)

The pre-assembled profiles are then securely installed on the TS-COR with the M10 hammerhead screw.

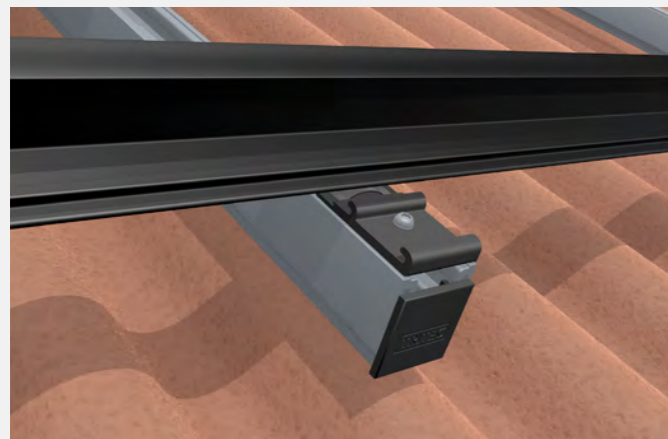

3. Clicking the TS insert profiles into the SafeClick

The insertion profiles are clicked into the SafeClick and are floatingly connected to the roof. Damage to the roof and module caused by thermal expansion is thus avoided.

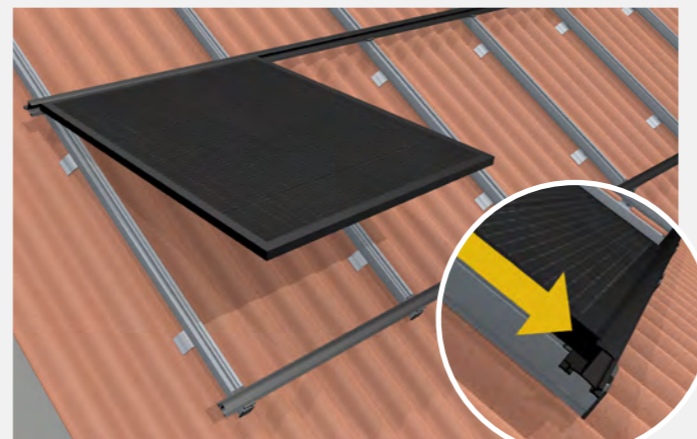

4. Inserting the modules into the TS insertion profiles

The modules are inserted into the insertion profiles and are held in place by their own weight - there is no need for additional fastening.









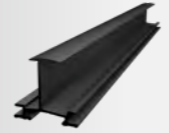

¹ New roof bolts may need to be placed in additional positions.

THE SYSTEM COMPONENTS

Extremely fast assembly with few components

With TRITEC you have the choice: Many components of the PV insertion system TRI-STAND are available in the colour selection „black“ and „blank“ (aluminum silver). Completely tailored to your needs: The profiles and variants marked with * are available in different lengths on request.

Colour key: ● black | ● blank

 <p>TRI-STAND insertion profile ● Standard</p> <ul style="list-style-type: none"> • variants: TS-30/32/35/38/40 • colour selection black / blank • available in different lengths* 	 <p>TRI-STAND end profile ● Optional</p> <ul style="list-style-type: none"> • variants: TS-30/32/35/40 • colour selection black / blank • available in different lengths* 	 <p>TRI-STAND universal profile UP-X 3,70 m ● Standard</p> <ul style="list-style-type: none"> • black, item no.: 1503404 • blank, item no.: 1503352 • other lengths on request* 	 <p>TRI-STAND universal profile connector UP-CX ● Standard</p> <ul style="list-style-type: none"> • pre-assembled incl. hammer head bolt • black, item no.: 1503404 • blank, item no.: 1503406
 <p>TRI-STAND SafeClick-Torx ● Standard</p> <ul style="list-style-type: none"> • black, item no.: 1502963 • blank, item no.: 1502870 	 <p>TRI-STAND insertion profile connector TS-C ● Standard</p> <ul style="list-style-type: none"> • black, item no.: 1502417 • blank, item no.: 1502216 	 <p>TRI-STAND anti-slip device AS, for increased loads** ● Standard</p> <ul style="list-style-type: none"> • substructure part for existing SafeClick, pre-assembled • item no.: 1503408 	 <p>TRI-STAND end bracket TS-E ● Standard</p> <ul style="list-style-type: none"> • black, item no.: 1502307 • blank, item no.: 1502214
 <p>TRI-STAND TS-COR, mounting bracket for corrugated fibre cement roof ● Standard</p> <ul style="list-style-type: none"> • item no.: 1503073 	 <p>TRI-STAND end cap for UP-X profile ● Accessories</p> <ul style="list-style-type: none"> • item no.: 1503185 		

* Information on lengths and part numbers on request.

** Point overloads on SafeClicks due to increased snow loads are effectively prevented by the use of TRI-STAND anti-slip protection.

LEARN MORE

Videos, planning and contact

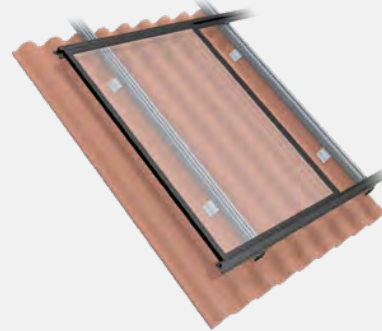

Simply scan the QR code or visit the following link to get more information about TRI-STAND for corrugated fibre cement, such as installation video, installation instructions and references.

www.tritec-energy.com/en/pv-mounting-systems/welleternit/



Just scan the QR code or visit the following link to watch the training video on our TRI-DESIGN planning software.

<https://www.youtube.com/watch?v=S9WGVIC8x2I>

The optimal mounting solution for every roof

TRITEC mounting systems combine over 30 years of photovoltaic experience. Our own products TRI-STAND, TRI-ROOF+, TRI-CLIP and TRI-FLAT Easyspeed offer optimum PV mounting solutions for the various requirements of different roof types and alignments. We attach great importance to the high-quality processing of the components as well as to the durability of the substructure.

For further information on our products and services, please visit our website at www.tritec-energy.com or our online shop at shop.tritec-energy.com.

You can also contact our experts directly at any time, who will be happy to answer any questions you may have.

Contact us at
info@tritec-energy.com

Website & online shop
www.tritec-energy.com
shop.tritec-energy.com