

Three-phase M-Combiner
MC100-T User Manual (SPD)



ATMOCE

About This Document

Corporate Contact Information

Company: Atmoce Holding B.V.
Address: Singel 250, 1016AB Amsterdam, Netherlands.
Email: info@atmoce.com
Telephone: +31 6 39877352

Disclaimer

- Product information is subject to change without prior notice. Every effort has been made in the preparation of this document to ensure accuracy of the contents, but all statements, information, and recommendations in this document do not constitute a warranty of any kind, express or implied.
- For optimum reliability and to meet warranty requirements, this product must be installed in accordance with the instructions in this manual.
- For warranty text, please refer to <https://www.atmoce.com/warranty>.

Applicable Scope

- This manual is intended for professional installation and maintenance personnel only.
- This manual mainly introduces the assembly, installation, configuration, maintenance and troubleshooting methods of the the MC100-T combiner.

Revision History

	Date	Version	Description
1	2024-10-30	Rev. 1.0.2	1. Add the SPD-related information. 2. Adjust grid-side and battery-side cable parameters.
2	2024-09-30	Rev. 1.0.1	1. Add the RCD-related information.
3	2024-06-30	Rev. 1.0.0	1. For testing purposes only

Contents

About This Document	I
Corporate Contact Information	I
Disclaimer	I
Applicable Scope	I
Revision History	II
Contents	III
Safety Information	1
1.1 Statement	1
1.2 Safety Labels	1
1.3 Personal Safety Instructions	2
1.4 M-Combiner Safety Instructions	3
1.5 Cable Safety Instructions	4
1.6 CT Safety Instructions	5
1.7 Environment Instructions	5
Product Information	6
2.1 Atmoce System	6
2.2 MC100-T	8
Storage Requirements	14
4.1 Prepare for Installation	15
4.2 Mount the M-Combiner	21
4.3 Remove the Protective Panel	22
4.4 Drill on the MC100-T	23
4.5 Wire to the M-Combiner	24
4.6 Power on the System	30
4.7 Activate the System	31
4.8 Lock the M-Combiner	31

Deployment Guide	32
5.1 Enter Site Details	33
5.2 Connect the Gateway to Atmoce-Cloud	34
5.3 Connect Devices to the Gateway	36
5.4 Configure Parameters	37
5.5 Create an Array	38
5.6 Check the Installation	39
Troubleshooting	40
6.1 MG100 LED Indicator Description	40
6.2 MG100 Reset Button	41
6.3 MG100 Issue Troubleshooting	42
6.4 MR100 LED Indicator	47
6.5 MR100 Self-Test Button	47
6.6 MR100 Issue Troubleshooting	48
6.7 Check the Alert Codes	49
6.8 Alarm Codes List	50
Maintenance	53
7.1 Remove MC100-T	53
7.2 Replace MC100-T	54
Technical Data	55
8.1 MC100-T Data Sheet	55
8.2 MG100 Data Sheet	57
8.3 M-Relay Data Sheet	58
Appendix 1: System Schematic Diagram	59
Appendix 2: Wire Diagram	60
Appendix 3: Terms and Abbreviations	61

Safety Information

1.1 Statement

- Before installing or using the Atmoce M-Combiner, please carefully read the user manual, all instructions and safety labels on the product, and any safety manuals available. Not following these safety instructions may result in personal injury, damage to the equipment, or invalidation of the warranty.
- DANGER, WARNING, CAUTION, and NOTE in this manual imply that they must be observed. You must also comply with relevant international, national or regional standards and industry practices. Atmoce assumes no responsibility for any violation of safe operation requirements or of safety standards for the design, manufacture and use of the equipment.
- This equipment should be used in an environment that meets the design specifications; otherwise, the equipment failure, abnormal equipment function or damage to components that arises shall not be covered by the warranty.
- All operations such as transport, storage, installation, operation, use, maintenance, etc. should comply with applicable laws, regulations, standards and specifications.

1.2 Safety Labels

To reduce the risk of electric shock and to ensure the safe installation and operation of the microinverter system, the following safety symbols are used throughout this manual to indicate hazardous conditions and important safety instructions.

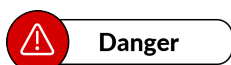

A label indicates a hazard with a high level of risk. If not avoided, it may result in serious personal injury or death.

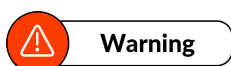

A label indicates a hazard with a medium level of risk. If not avoided, it may result in serious personal injury or death.

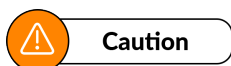

A label indicates a hazard with a low level of risk. If not avoided, it may result in serious personal injury or death.

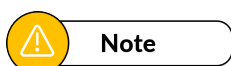

A label indicates a safety hazard and risk of device damage. If not avoided, it may result in equipment damage, data loss, reduced performance, and other consequences, but does not involve personal injury.

1.3 Personal Safety Instructions



Danger

- The installation process is strictly prohibited to operate with electricity. It is prohibited to install or remove cables with electricity. The moment the cable core touches the conductor, it will generate electric arc or electric spark, which can lead to fire or personal injury.
- When equipment is energised, unregulated and incorrect operation may produce a fire, electric shock or explosion, resulting in injury, death or property damage.
- Do not work alone. When using or working near electrical equipment, someone should be within earshot or close enough to help you. Remove rings, bracelets, necklaces, watches, etc. when operating PV modules, microinverters, M-Combiners and other electrical equipment.



Warning

- Specialised protective equipment must be used during operations, such as protective clothing, insulated shoes, goggles, helmets and insulated gloves.
- Do not ignore warnings, cautions and precautions in manuals and on equipment.
- During operation of the equipment, if a malfunction is detected that could result in personal injury or equipment damage, immediately terminate the operation, report it to the person in charge, and take effective protective measures.
- Do not apply power to the equipment before installation is completed or without confirmation from a qualified person.



Note

- Do not install by untrained personnel. Atmoce shall not be liable for any loss or damage caused by improper use, installation, or misuse of the product.
- Personnel responsible for installing and maintaining the equipment must first be trained in the correct methods of operation and be aware of the various safety precautions and relevant standards in their country/region.
- Personnel in special scenarios such as electrical operation, work at heights, and operation of special equipment must have special operating qualifications required by the local country/region.

1.4 M-Combiner Safety Instructions



Danger

- Do not attempt to repair the combiner without authorization, as it does not contain any user repairable components. Unauthorized disassembly, repair, or destruction of the combiner and its internal components will void the warranty. In case of malfunction of the combiner, please contact Atmoce for technical assistance (web link).
- Do not use the combiner in any way other than as specified by Atmoce as unauthorized use may result in personal injury or damage to the equipment.
- Do not use accessories that have not been approved by Atmoce as this may result in equipment damage or personal injury.
- Since the combiner is powered by multiple sources, please confirm that all the circuit breakers are in the Off position before any installation, maintenance or cleaning.
- Do not operate the Atmoce combiner if the appearance is damaged.



Warning

- Check that the cables and connectors to ensure that they are in good condition. Do not operate the combiner with damaged or unqualified cables or connectors.
- Do not disassemble the enclosure and protective panel of the combiner except for necessary maintenance.
- Use the circuit-breakers in the Atmoce combiner in accordance with their markings and do not change their purpose without authorisation.



Note

- When installing the Atmoce combiner, comply with the installation regulations and/or local electrical regulations.
- The combiner is suitable for use in environments with a maximum ambient temperature of 50°C.
- When installing the Atmoce combiner, use copper wires with a temperature resistance of 90°C or higher. Please take full account of local regulations.
- Please select cables that meet safety requirements based on the parameters of the circuit breaker, check the cables and connectors to ensure that they are in good condition and in rated condition.
- Do not connect the combiner to the grid or connect the AC circuit before completing all installation procedures and obtaining approval from the utility company.
- Provide cable supports at least every 1 meter.

1.5 Cable Safety Instructions

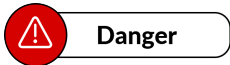

- Do not attempt to install cables unless the circuit is disconnected.
- Take care not to damage the copper conductor of the cable when stripping the cable sheath. If the exposed wires are damaged, the system may not function properly.

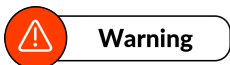

- Ensure that all AC and DC wiring is correct and that none of the AC or DC cables are pinched, shorted, or damaged. Ensure that all AC junction boxes are properly closed.
- Do not leave the connectors on the cable uncovered for long periods of time. Unused AC connectors must be covered with caps because they are energised when the system is powered on.
- All cables must be firmly connected, well insulated, and of appropriate specifications.
- If it is necessary to remove the sealing caps or connectors, use the disconnection tool supplied by Atmoce.

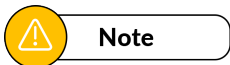

- Cable selection and routing must follow local laws, regulations and norms.
- When routing cables, make sure that the minimum bending radius of cables is 8xOD (8 times the cable's outer diameter) or r55mm.
- In the process of laying power cables, if the length of the power cable is found to be insufficient, the power cable must be replaced, and it is strictly prohibited to make joints or welding points in the power cable.
- Do not expose terminals or cable connectors to continuous tension and avoid pulling or bending the cable at the connection.
- Avoid routing cables with overly tight cable clamps.
- Cable crossing holes should be free of sharp edges to avoid damage to the cables by sharp edges, burrs, and so on.
- Ensure that the cable connector is kept free from dirt or debris and prevent dirt or debris from entering the connector.

1.6 CT Safety Instructions



Danger

- To avoid the risk of electric shock, always disconnect the circuit from the distribution system (the distribution panel) before installing or repairing the current transformers (CTs).
- Do not install CTs when the sensing circuit is energised. Before turning on the sensing circuit, the CT signal cable must be installed in the terminal.
- Only qualified personnel should troubleshoot, install or replace CTs.
- Mount the CTs and cables so that they do not come into direct contact with live terminals.



Warning

- Failure to follow these instructions may result in damage to the equipment.
- Please observe national and local electrical regulations for all electrical installations.

1.7 Environment Instructions



Danger

- Do not place the equipment in an environment where flammable or explosive gases or fumes are present, and it is forbidden to carry out any operation in such an operation.
- Do not install or use the equipment in a potentially explosive environment.
- Do not place the equipment near sources of heat or ignition, such as fireworks, candles, heaters or other heat generating devices, as heat from the equipment may result in damage to the equipment or cause a fire.
- Do not expose terminals or connectors to direct sunlight.



Warning

- Do not attempt to install the equipment in adverse weather conditions.
- Do not expose terminals or connectors to directed pressurized liquids (such as water jets).
- Do not immerse the terminals or connectors in liquid.
- Do not install the equipment in an environment with volatile gases, corrosive gases or organic solvents.
- Do not install the equipment in an area with strong vibration, strong noise sources, and strong electromagnetic field interference.
- When installing the equipment, make sure that the mounting surface is sturdy and meets the equipment load-bearing requirements.
- After installing the equipment, remove empty packing materials, such as cardboard boxes, foam, plastic, cable ties, etc., from the equipment area.

Product Information

2.1 Atmoce System

2.1.1 Overview

The system includes the following components:

- **Microinverter:** MI-400/MI-425/MI-450/MI-500, etc. Atmoce microinverters are compact and efficient devices for home distribution systems. The grid-connected microinverter converts the DC output of a PV module into grid-compliant AC power.
- **M-Combiner:** MC100/MC100L/MC100-T, etc. The M-Combiner is an energy management equipment that ensures the proper connection of microinverters, batteries and loads, and enables grid connection.
- **Atmoce-Cloud:** A web-based energy management portal. Users can use it to view detailed operational data, manage multiple energy systems, and resolve system issues remotely. For more information, please visit <https://www.atmocecloud.com>.
- **Atmozen app:** A mobile application suitable for iOS and Android devices with the following main functions: remote module level management, home energy management, etc.
- **Battery**
- **AC EV charger, heat pump or other residential loads**

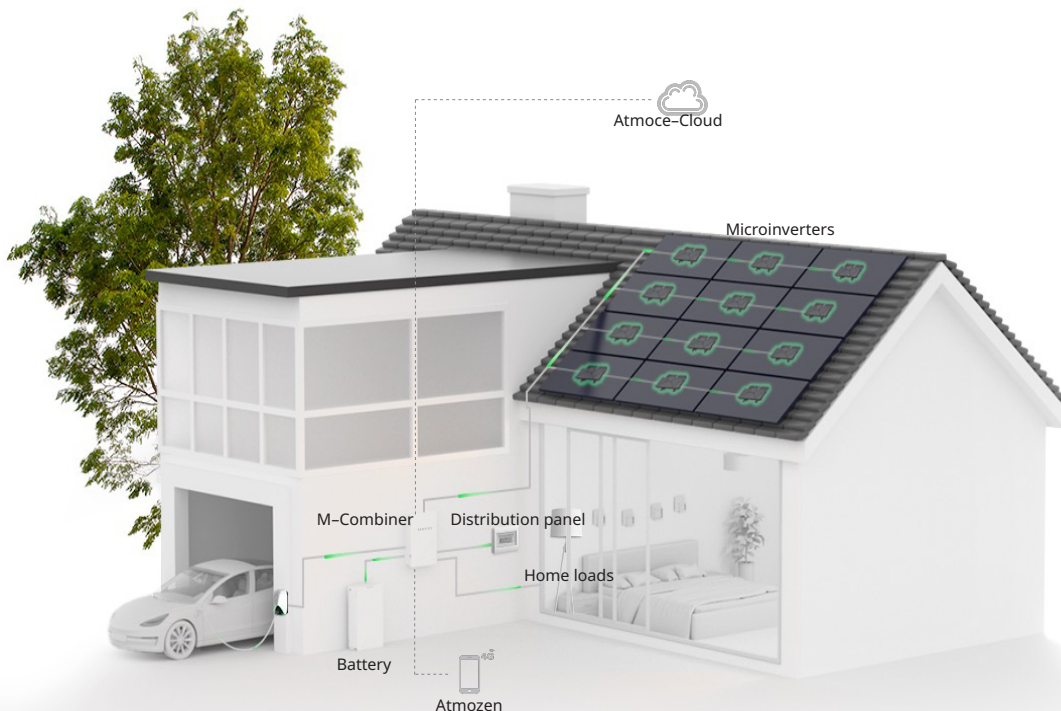

2.1.2 Functional characteristics

- **Safety**

Atmoce system eliminates any potential hazards associated with high-voltage direct current (DC), ensuring that homeowners and installers are not exposed to dangerous electrical environments. In addition, the system is resistant to extreme weather conditions and can operate reliably even in harsh environments.

- **Flexibility & Intelligence**

The Atmoce system's AC-coupled architecture provides the flexibility to expand the system as needed. This feature allows users to easily add new PV modules. In addition, the system incorporates digital real-time management to accurately measure and manage the power generation status.

- **Excellent Compatibility**

The system offers excellent compatibility, based on the grid-forming design, which ensures seamless integration with the grid. In addition, the system supports multi-energy access, such as solar energy, the grid, and even wind energy. This versatility ensures that the system can adapt to changing energy demands and sources, providing a reliable and sustainable energy solution for the future.

2.2 MC100-T

2.2.1 Overview

The three-phase M-Combiner (MC100-T) is an integrated control and power equipment that ensures the proper connection of microinverters, batteries and loads, and achieves grid connection. By integrating the M-Gateway MG100, an intelligent energy controller, the combiner can manage the system performance and control the devices above. The combiner communicates with the Atmoce-Cloud and Atmozen app, allowing you to view the status of energy production and consumption in the home.

2.2.2 Functional Characteristics

- **Stable, Continuous, Uninterrupted Power Supply**

The core of the system is an M-Gateway that intelligently manages and optimises energy flows to ensure a stable and reliable power supply for your home. In addition, the system offers the flexibility to utilise a variety of energy sources, including renewable energy, grid power and energy storage systems.

- **Safety Priority with IP65 and Insulation Materials**

The system is IP65-rated and double-insulated to protect against dust, water and other environmental hazards. This rugged design allows for easy outdoor installation and ensures that our systems can provide power regardless of the weather condition.

- **Easy Installation**

Atmoce systems feature fast, trouble-free installation, eliminating the need for complex, time-consuming reassembly of an in-house power distribution system. Our Atmozen app guides you through each step, ensuring that your system is installed correctly and operates efficiently.

2.2.3 Product Structure

Section A. MC100-T Dimensions

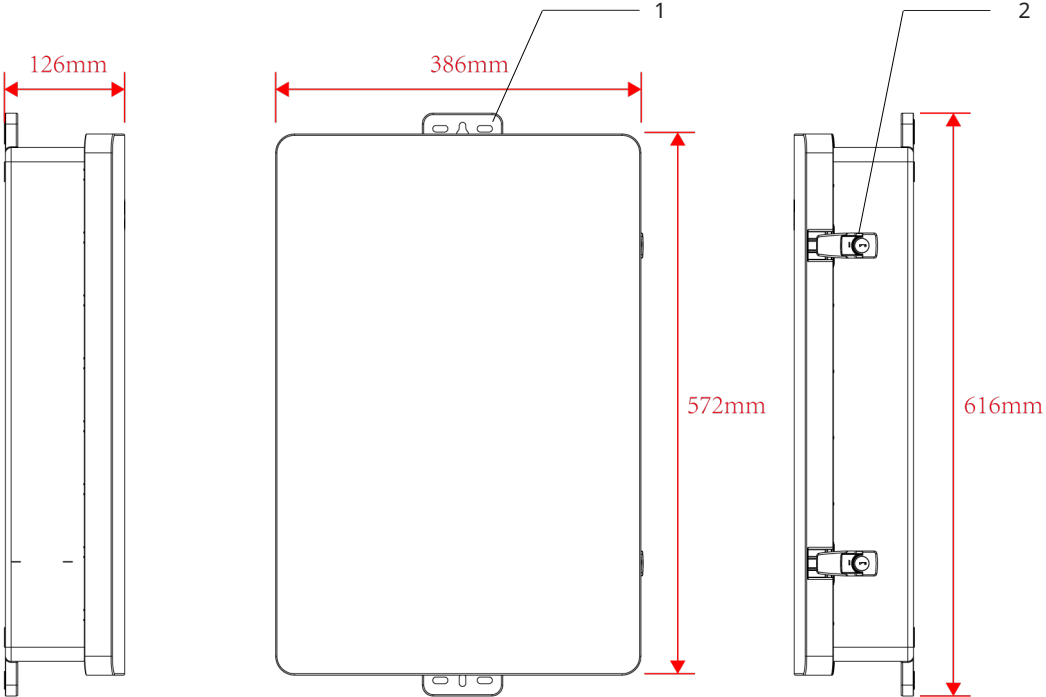

- 1. Mounting Tab
- 2. Door Locks

Section B. Items inside the MC100-T

Open the door of the MC100-T and refer to the following figure and table for pre-installed components in the MC100-T.

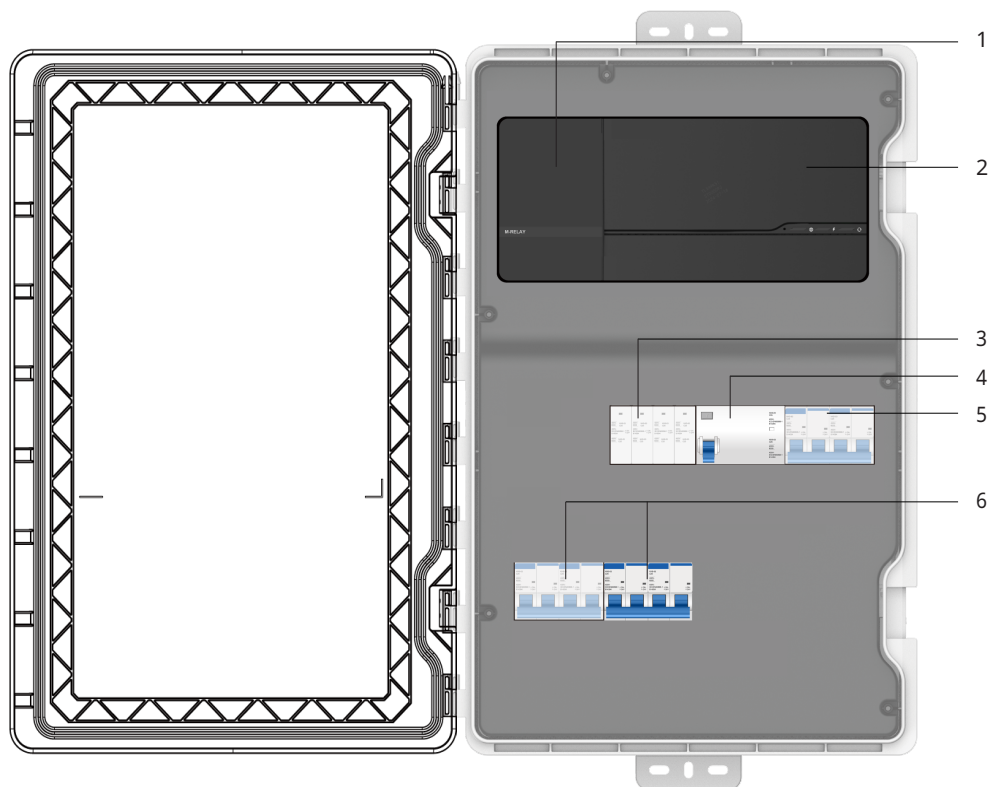

	Catelog	Model	Description
1	M-Relay	MR100	/
2	M-Gateway	MG100	/
3	SPD	NXU-II G	4-pole, In: 20kA
4	Grid breaker	NL1-63 63A 4P 30mA	4-pole, 63A, 400V
5	Battery breaker	NXB-63 D63 4P	4-pole, 63A, 400V, 6kA
6	PV breaker 1 & 2	NXB-63 C20 4P	4-pole, 20A, 400V, 6kA

Remove the protective panel and refer to the following figure and table for pre-installed components in the MC100-T.

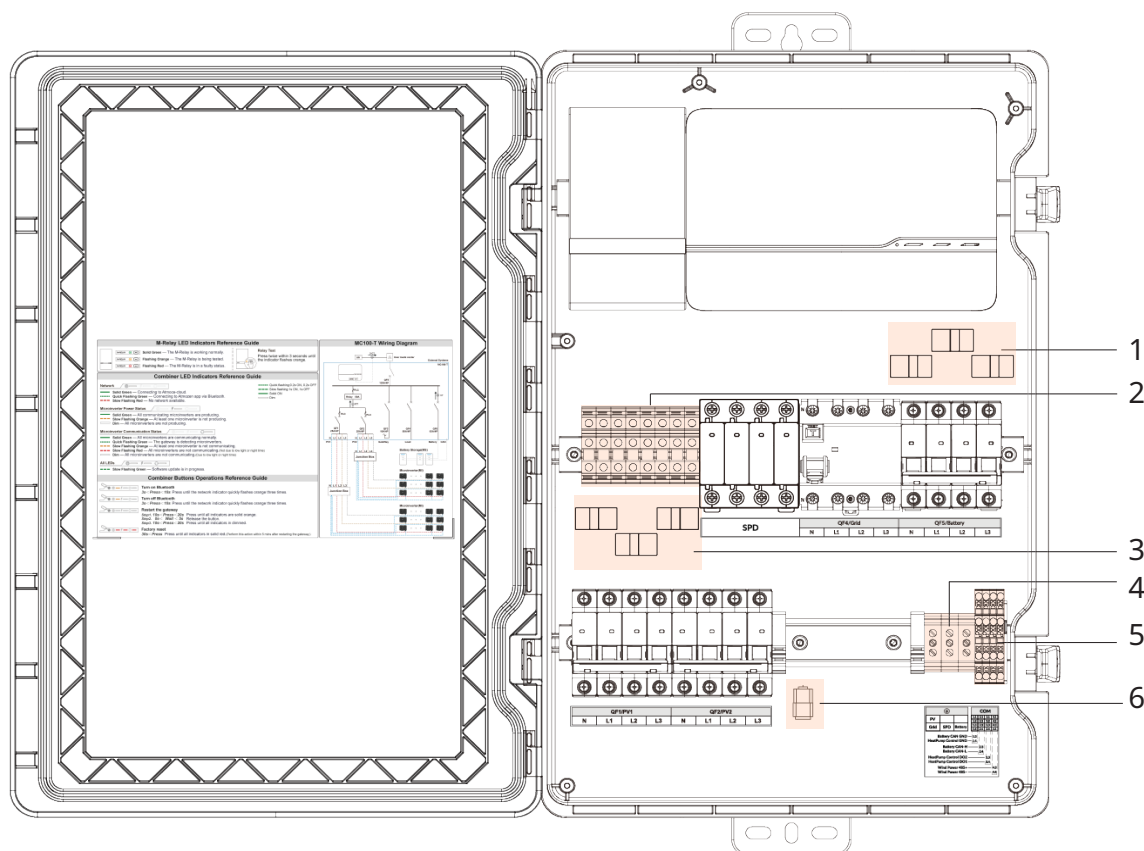

	Catalog	Model
1	Battery CT	SK9016.1
2	Power terminal block	RTB10-TWIN
3	Microinverter CT	SK9016.1
4	PE terminal block	RUSLKG 16N
5	Communication terminal block	RPVTT2.5 GY
6	Reserved interface for consumption CT	RJ45 connector

2.2.4 Product Labels

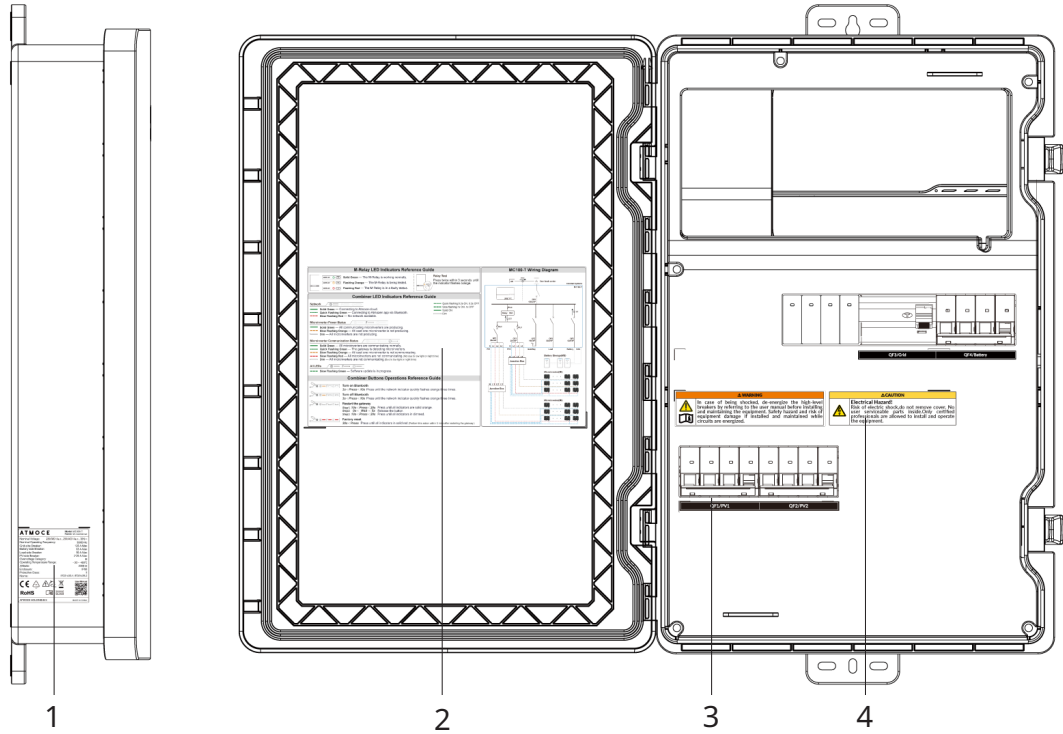

1. Nameplate Label 2. MC100-T LED Indicator and Wire Diagram
 3. Breaker Function and Polarity Description 4. MC100-T Safety Instruction

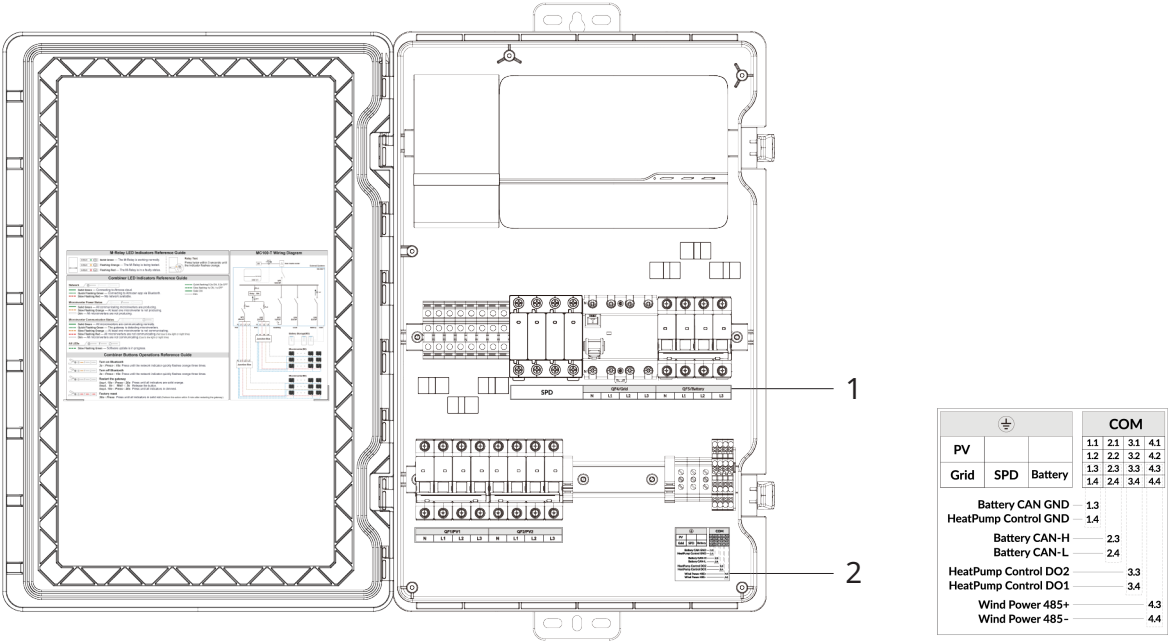

1. Breaker Function and Polarity Description
 2. PE and Communication Wire Diagram

Section A. MC100-T Safety Instructions





The following safety instructions appear on the protective panel:

⚠ WARNING	
	<p>In case of being shocked, de-energize the high-level breakers by referring to the user manual before installing and maintaining the equipment. Safety hazard and risk of equipment damage if installed and maintained while circuits are energized.</p>

⚠ CAUTION	
	<p>Electrical Hazard! Risk of electric shock, do not remove cover. No user serviceable parts inside. Only certified professionals are allowed to install and operate the equipment.</p>

Section B. Nameplate Label Symbols

The following symbols appear on the nameplate label:

Symbol	Description
	Made of PC material. Do not heat or expose to direct sunlight.
	The product has passed CE related certification.
	Waste of electrical and electronic equipment. This product cannot be treated as household waste. Please dispose of it in accordance with local regulations or return it to Atmoce.
<p>RoHS</p>	Restriction of Hazardous Substances. The product has passed RoHS certification.
	Delayed discharge. After the device is powered off, please wait 60 seconds for the unit to fully discharge.
	Please read the user manual before using the equipment.

Storage Requirements

If the product is not to be used and installed immediately, it must be stored in accordance with the following requirements:





- Do not remove the outer packaging of the product.
- The storage temperature should be maintained within $-40\text{ }^{\circ}\text{C}$ to $+70\text{ }^{\circ}\text{C}$.
- The relative humidity should be maintained between 40% RH and 60% RH.
- Store the product in a clean and dry place, away from dust and moisture.
- Stack no more than 8 layers high. When stacking, please be careful when placing the packaging box to avoid personal injury or equipment damage caused by equipment tipping over.
- Regular inspections are required during storage (once every three months recommended). If the product has been placed in storage for two years or longer, it must be inspected and tested by qualified personnel before use.

Installation

4.1 Prepare for Installation

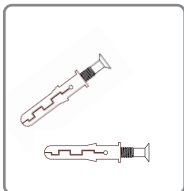
4.1.1 Check the Items in the Package

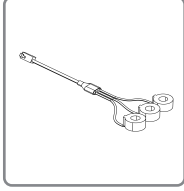
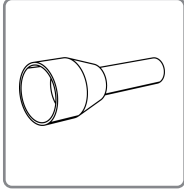
Please make sure that the following items are included in the package before installation.

Item	Catalog	Model	Description
	Wall anchors and screws	M8	Mount the combiner on the wall
	Waterproof glands	HQCF-M40-AD 42.5 HQCF-M32-AD 34.5 HQCF-M25-AD 28.5	Rain-tight fittings on the holes
	Consumption CT	SK9017	Measure electricity consumption in the home
	Cold-press terminals	/	Cover the cable ends
	Key of the combiner	/	Lock the door of the combiner
	Quick installation guide	/	Guide on-site installation

4.1.2 Check the Grid Voltage

Atmoce system should connect to a three-phase grid. Measure AC line voltages at the point of connection to confirm that they are within the ranges.

Grid setup	Voltage range
Three-phase	L1, L2, L3 to N 184 to 276 Vac

4.1.3 Plan the Number of Microinverters on each PV AC Branch

The number of microinverters on each PV AC branch shall not exceed the following limits respectively:

Model	Max microinverters/20A branch ^a	Max microinverters/25A branch ^b
MI-400	9	11
MI-425	8	10
MI-450	8	10
MI-500	7	9

a. Output overcurrent protection is provided by a type C circuit breaker inside the M-Combiner, rated at 20A for MI-400/MI-425/MI-450/MI-500.

b. You can replace the PV breaker with one rated at 25A and select the cables that meet the local electrical code requirements.

4.1.4 Prepare the Cables

To properly set up the system, it is necessary to select the appropriate cables. The table below shows the recommended cable requirements. The breakers and cables can be adjusted to meet local electrical codes.

Connection	Recommended cable size		Terminal requirement
Microinverter	Power cable	2.5 to 4 mm ²	Cold-pressed Terminal
Grid	Power cable	10 to 16 mm ²	Cold-pressed Terminal
	Consumption CT signal cable	Provided by Atmoce	/
Battery	Power cable	10 to 16 mm ²	Cold-pressed Terminal
	CAN cable	0.25 to 0.75 mm ²	Cold-pressed Terminal
Load	Control cable	0.25 to 0.75 mm ²	Cold-pressed Terminal
	ETH cable	802.3, Cat 6 UTP ethernet cable	RJ45
Router	ETH cable	802.3, Cat 6 UTP ethernet cable	RJ45

NOTE:

- When connecting the cables to the M-Combiner, you must cover the cable ends by using the proper cold-press terminal provided in the package.
- When stripping the cable, remove approximately 12–15 mm of the insulation layer from the power cable and 8 mm of the insulation layer from the communication cable.

4.1.5 Prepare the Tools and Materials

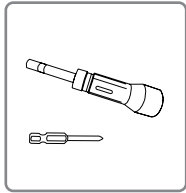

Screwdriver
(M8)

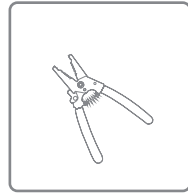

Wire stripper

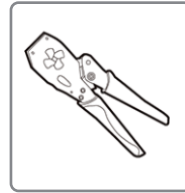

Power line crimper

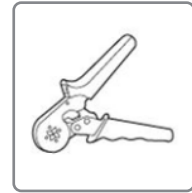

Communication line
crimper

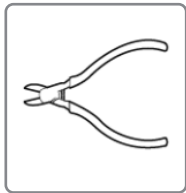

Diagonal cutter

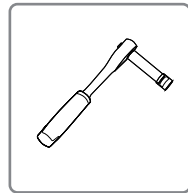

Torque wrench

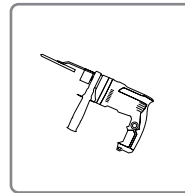

Drill

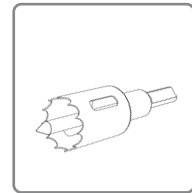

Hole cutter with pilot
($\Phi 40$, $\Phi 32$ mm and
 $\Phi 25$ mm)

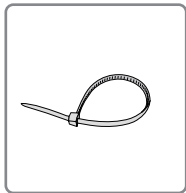

Tie wrap

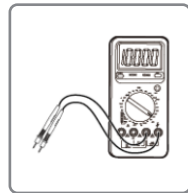

Multimeter

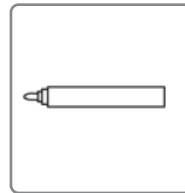

Marking pen

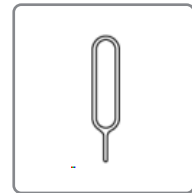

Needle



Tape measure

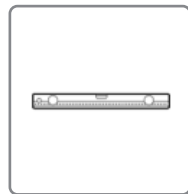

Spirit level



Corrugated protective
pipe

4.1.6 Prepare the Safety Equipment

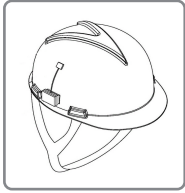

Safety helmet

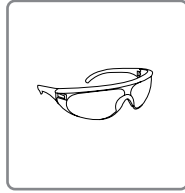

Protective goggles

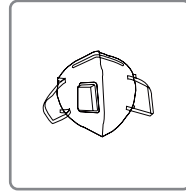

Mask

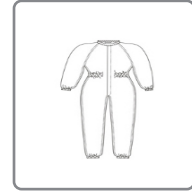

Safety clothing

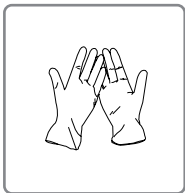

Safety gloves

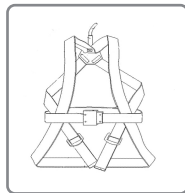

Safety belt



Safety shoes

4.1.7 Download the Atmozen App

Download the latest version of the Atmozen app. Open and log in to your account. You can track the progress of system installation with this app.



4.1.8 Select How the Device Connects to the Internet

There are two methods: Wi-Fi, and Ethernet.

- For Ethernet connection, use 802.3-compliant Cat 6 UTP Ethernet cables.
- For Wi-Fi connection, install the M-Combiner within a 10-m radius from the home router to ensure strong Wi-Fi signals.

4.2 Mount the M-Combiner

- Use a tape measure and make a mark on the wall at least 1,000 mm vertically from the ground.
- Measure approximately 586 mm above the mark and make another mark.
- Drill at the two marks by using an electric drill with an bit ($\Phi 10$).
- Insert the wall anchors (provided in the package) in to the holes, and then insert the M8 screw into the TOP hole but do not completely tighten it.
- Hang the top mounting tab on the screw and check if the combiner is level by using a spirit level, and then insert the screw into the bottom hole.
- Tighten the M8 screws by using a Phillips #2 screwdriver with a torque of 9–14 N·m.

NOTE:

- Do not expose the M-Combiner to direct sunlight, unless installing a sunshade.
- The signal cable of the consumption CT is 5 meters long. Therefore the M-Combiner must be installed closed to the distribution panel.

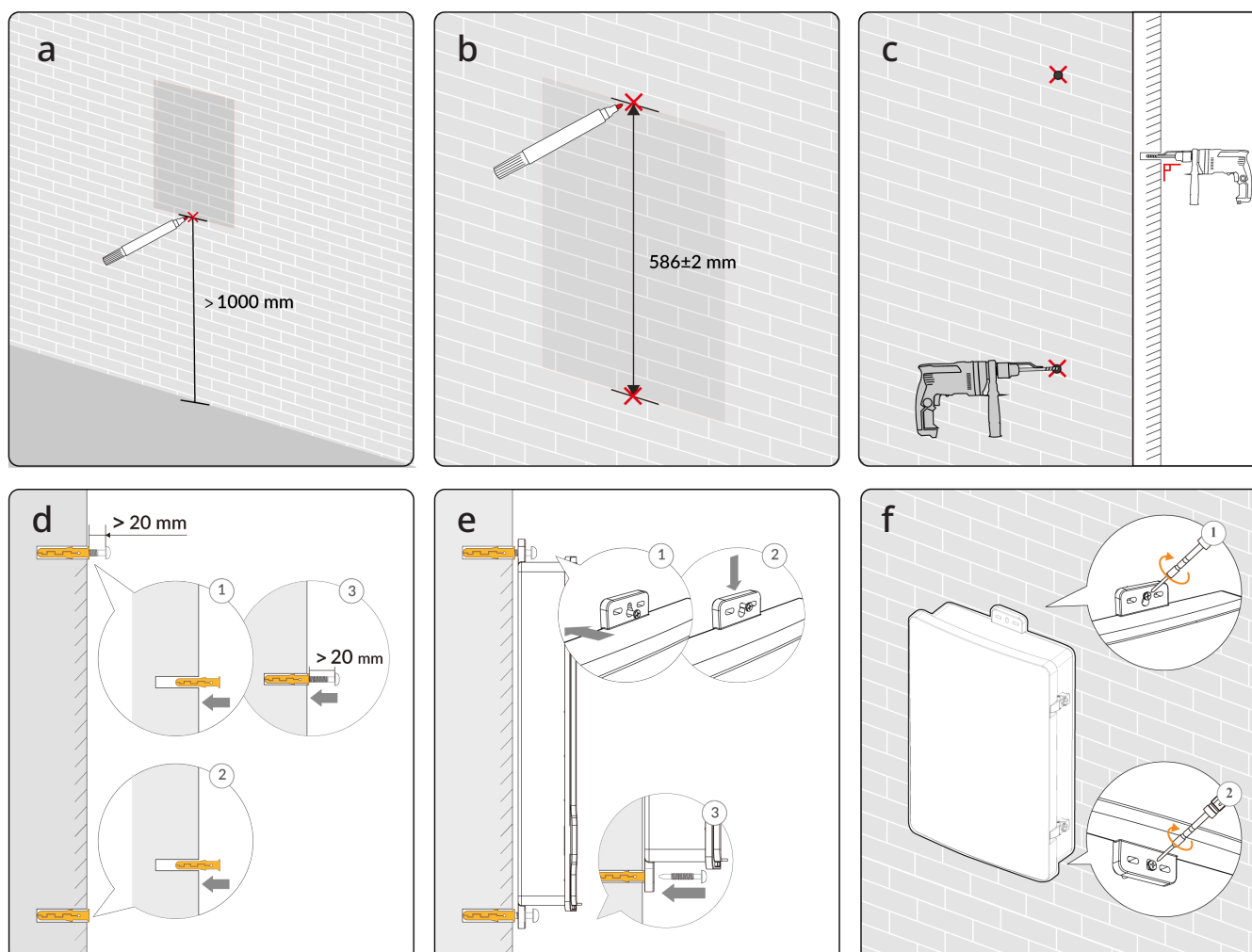

4.3 Remove the Protective Panel

- a. Open the combiner door by using the key provided in the package with quick installation guide.
- b. Use a Phillips 2# screwdriver to remove the protective panel.

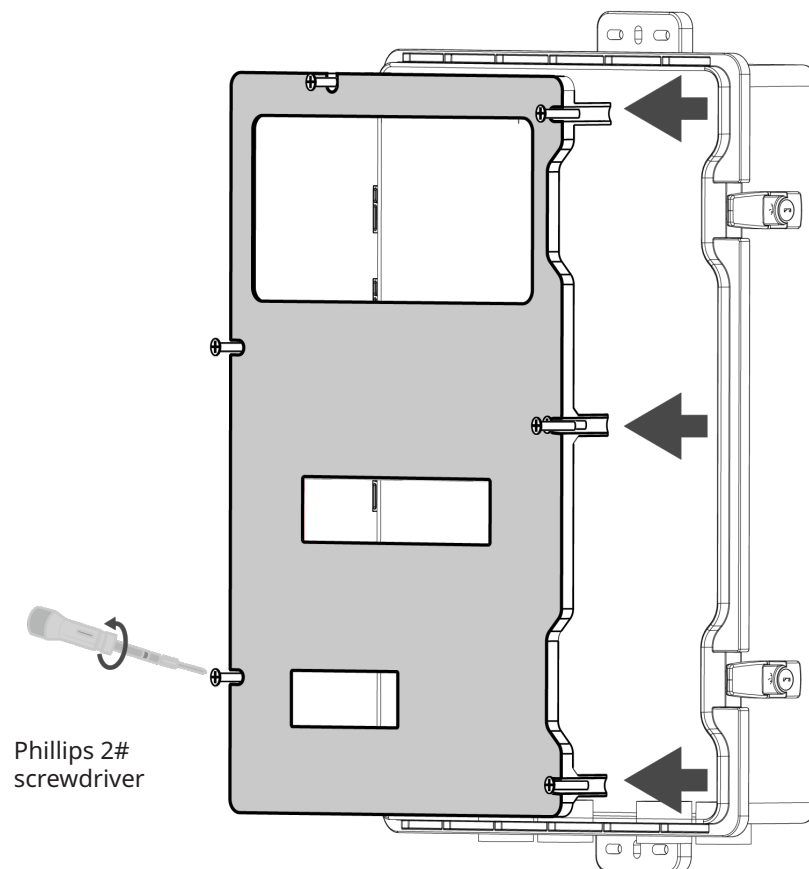

4.4 Drill on the MC100-T

a. Use the electrical hole cutter with a pilot drill bit to drill holes. The drilling areas and recommended purposes are indicated at the bottom of the M-Combiner.

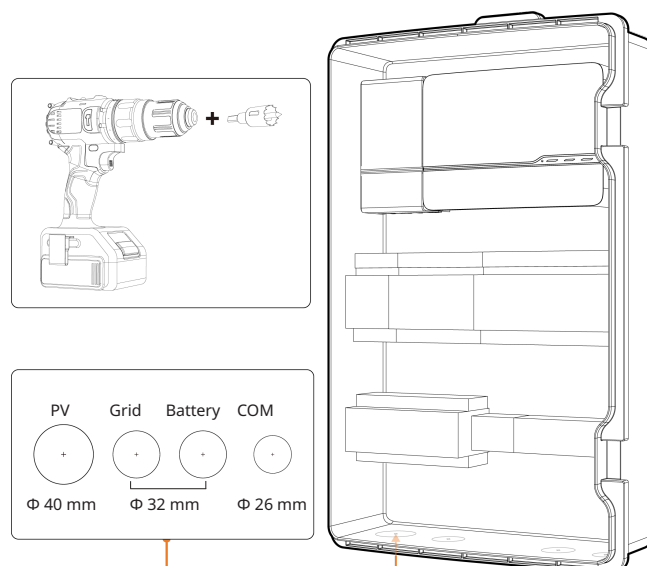

NOTE:

- Make sure that the edges of the holes do not exceed the indicated circles.

b. Install the corresponding rain-tight fittings to the holes. Several waterproof glands can be found in the package.

c. Tighten the lock nuts of the glands with a torque of 4-5 N·m and the sealing nuts with a torque of 7-7.5 N·m.

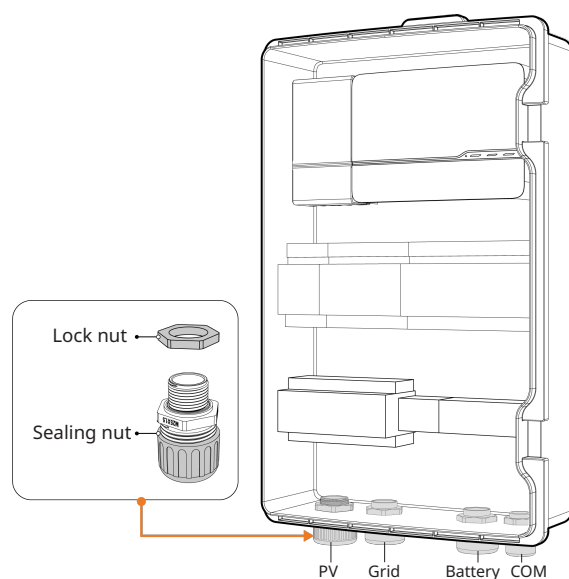

4.5 Wire to the M-Combiner

4.5.1 Wire from the PV Branch (Microinverter)

- Bring in the cables from the PV branch circuit through the PV hole of the combiner.
- Connect the cables (N, L1, L2 and L3) from the PV branch circuit to the PV breaker(s). Observe the polarity mark at each breaker.
- Tighten the screws by using a Phillips #2 screwdriver with a torque of 2–2.5 N·m.
- Optional: Wire the ground cable from the PV rack system to the AC junction box and connect this cable to the PE terminal block in MC100-T.

NOTE:

- Ensure that the N cable of the PV branch is always connected to the leftmost terminal of the PV breaker.

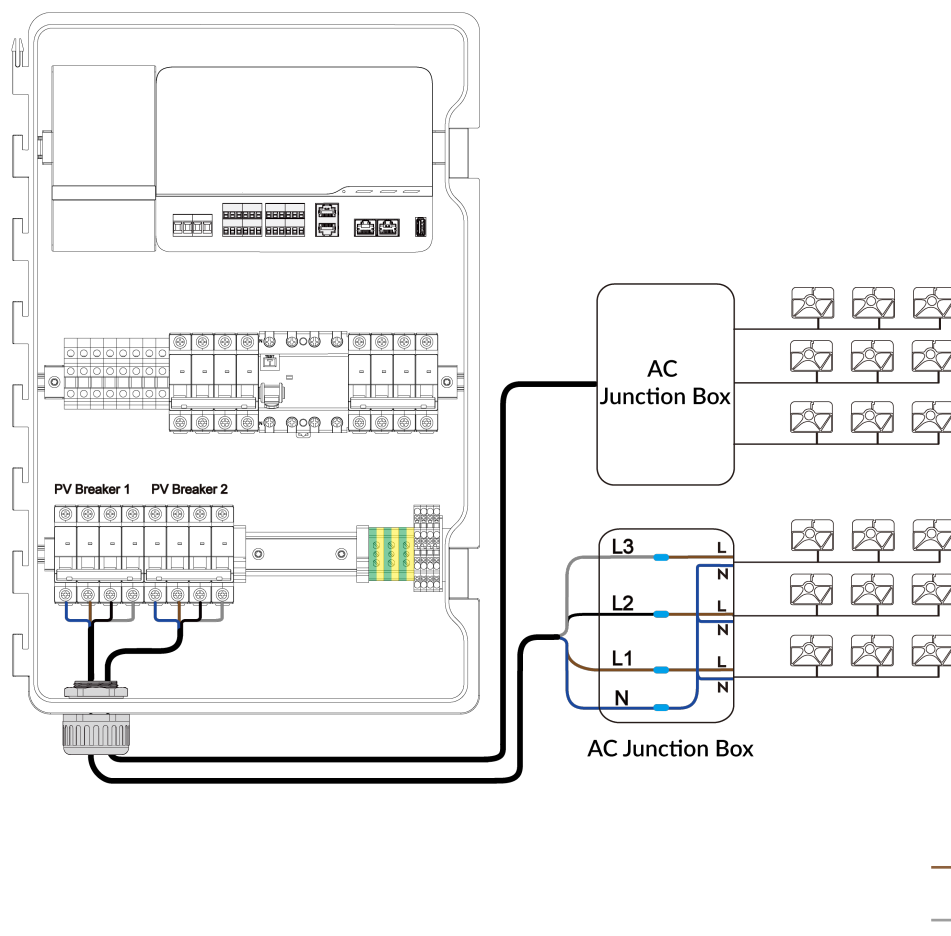

4.5.2 Wire from the Distribution Panel (Grid)

Section A. Wire the power cables

- Bring in the cables from the distribution panel through the grid hole of the combiner.
- Connect the cables (N, L1, L2 and L3) from the distribution panel to the grid breaker and connect the ground cable to the PE terminal block as shown below.
- Tighten the screws by using a Phillips #2 screwdriver with a torque of 2–2.5 N·m.

NOTE:

- Ensure that the N cable is connected to the grid neutral line to avoid damaging the devices and voiding the warranty.
- Ensure that the cable sequences (N, L1, L2 and L3) of the grid breaker, M-Combiner breaker and main breaker are consistent.

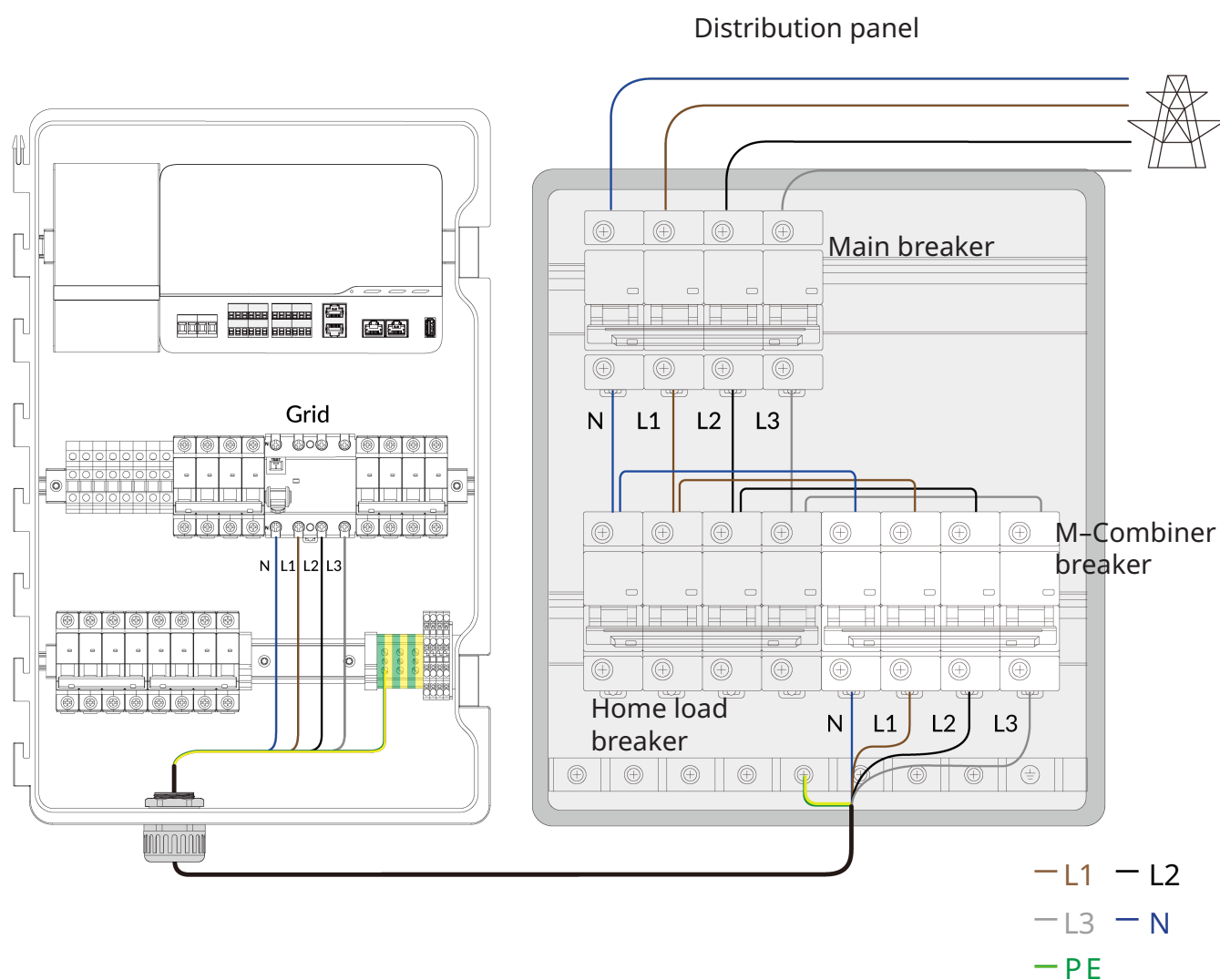

Section B. Wire the consumption CTs

- a. Install the consumption CTs for electricity metering. You can find the CTs in the combiner.
- b. To install the CTs, perform the following steps:
 - Connect the CTs' signal line to the reserved RJ45 terminal as shown above.
 - Remove the L1, L2 and L3 cables of the main breaker in the distribution panel.
 - Locate the arrow on the CTs' labels and thread the L1, L2 and L3 cables into the CTs with labels "L1," "L2," and "L3," respectively. The CTs' arrows must point away from the grid.
 - Reconnect the L1, L2 and L3 cables to the main breaker and tighten the screws.

NOTE:

To guarantee the correct measurement of home energy consumption, observe the following rules:

- The arrow on the CT must point away from the grid.
- As shown in the system schematic diagram (Appendix 1), ensure that the CTs with labels "L1," "L2," and "L3," are installed on the same power line as the L1, L2 and L3 of the breaker in the M-combiner respectively.

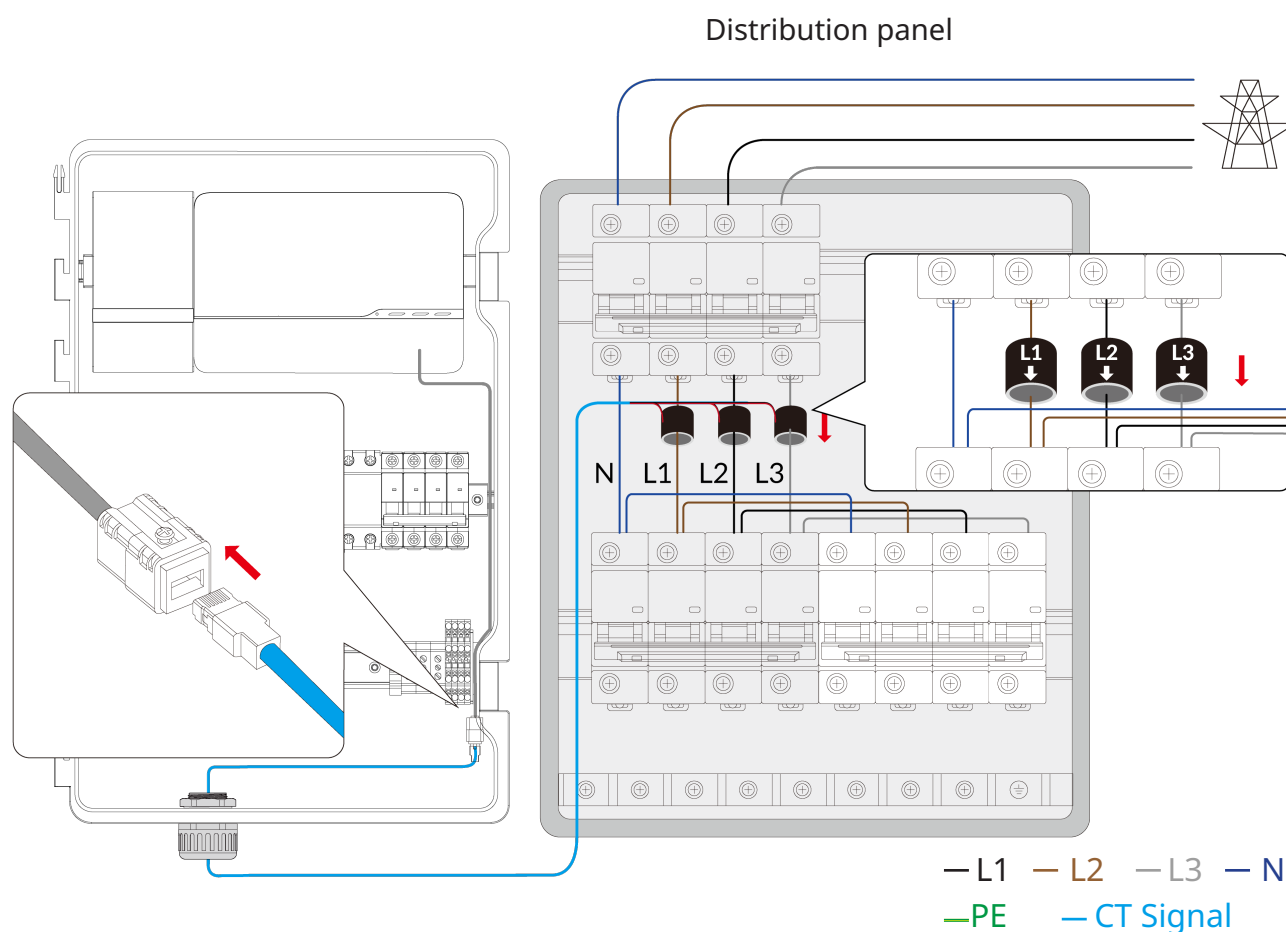

4.5.3 (Optional) Wire from the Battery

- a. Bring in the cables from the battery through the battery hole of the combiner.
- b. Connect the cables (N, L1, L2 and L3) from the battery to the battery breaker and connect the ground cable to the PE terminal block.
- c. Tighten the screws by using a Phillips #2 screwdriver with a torque of 2–2.5 N·m.
- d. Connect the CAN COM cable of the battery to the terminal as shown in the following figure.

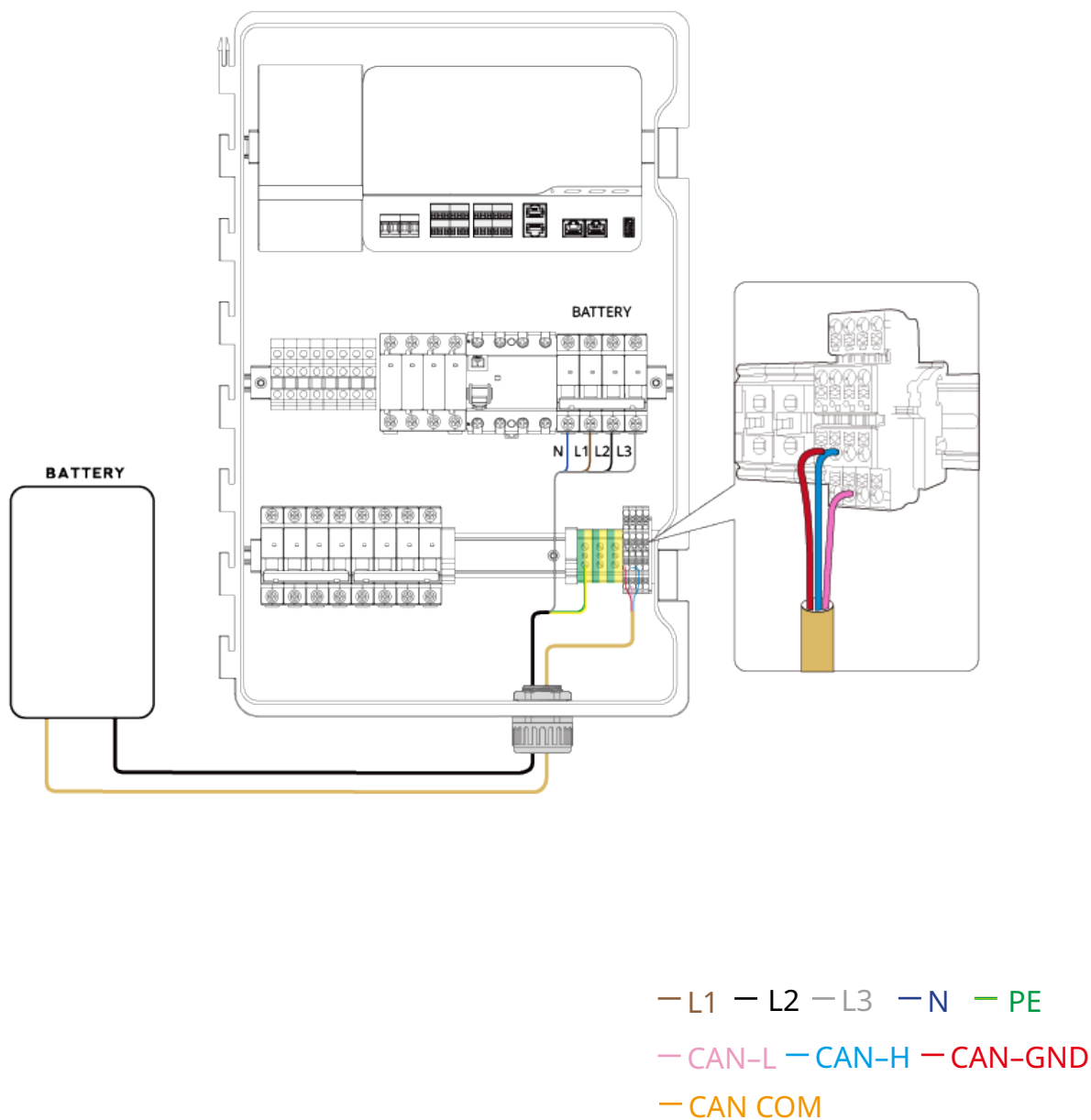

4.5.4 (Optional) Wire from Loads

- a. Bring in the cables from the load through the COM hole of the combiner.
- b. The MC100-T supports RS485, ETH and CTRL communication. Connect the cables from the load to the communication terminal block as shown in the figure.

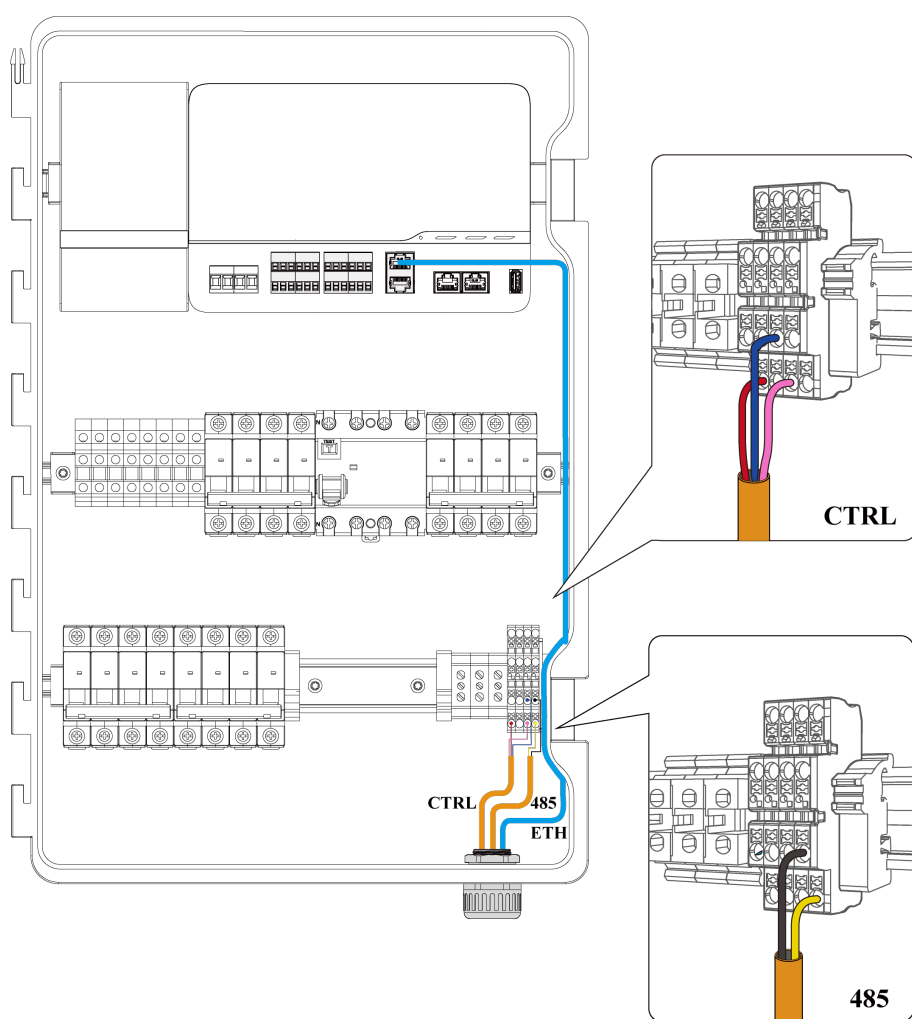

- DO1 — DO2 — CTRL GND
- 485+ — 485- — ETH
- COM

4.5.5 (Optional) Wire from the Router

- When you use ETH to connect to Atmoce-Cloud, bring in the wire from the home broadband router through the COM hole of the combiner.
- Connect the 802.3 Cat 6 UTP ethernet cable to the RJ45 terminal in the combiner as shown in the figure.

NOTE:

- This interface is used only for communication with home routers.

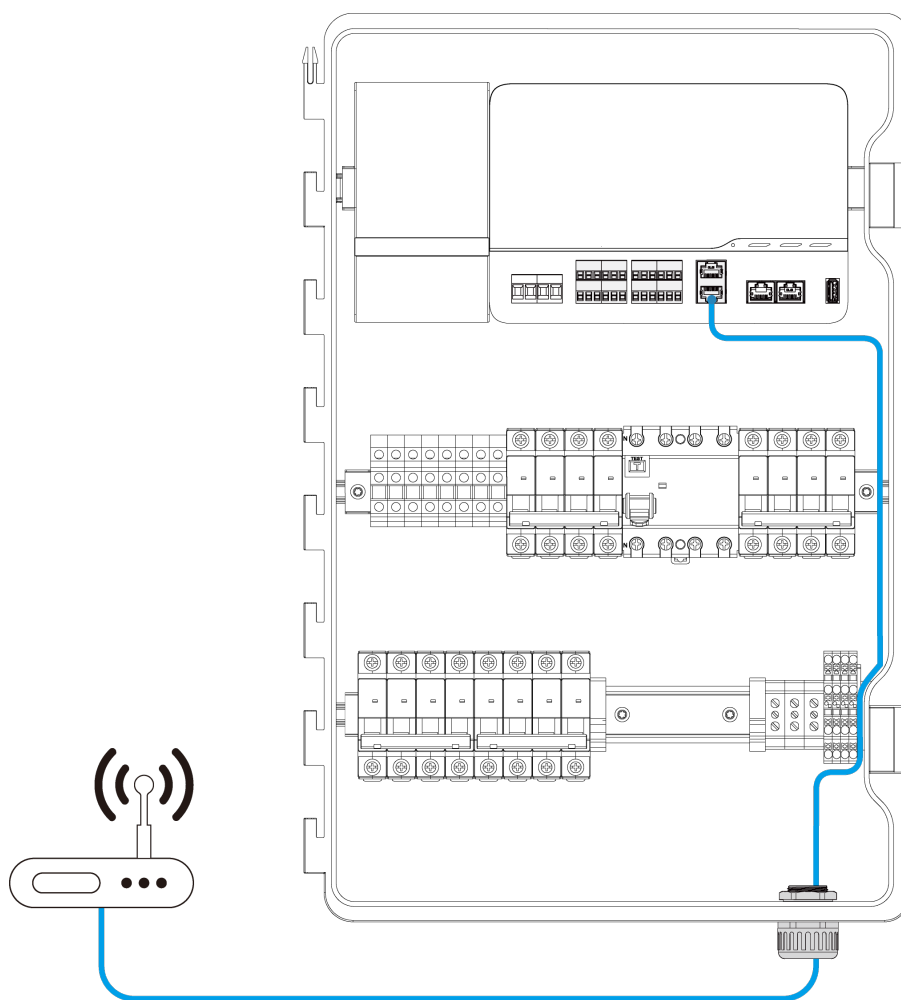

— ETH

4.6 Power on the System

- a. Turn on the main breaker and M-Combiner breaker in the distribution panel.
- b. To check the phase sequence, perform the following steps:
 - Use the multimeter to measure the voltage between the N pole and L1 pole of the grid breaker as shown in the figure.
 - Measure the voltage between the N pole and L2 pole.
 - Measure the voltage between the N pole and L3 pole.

NOTE:

- If the voltage value is beyond the range (184 to 276 V), do not switch on the grid breaker inside the combiner. Check the cable connection to avoid damaging the device and voiding the warranty.

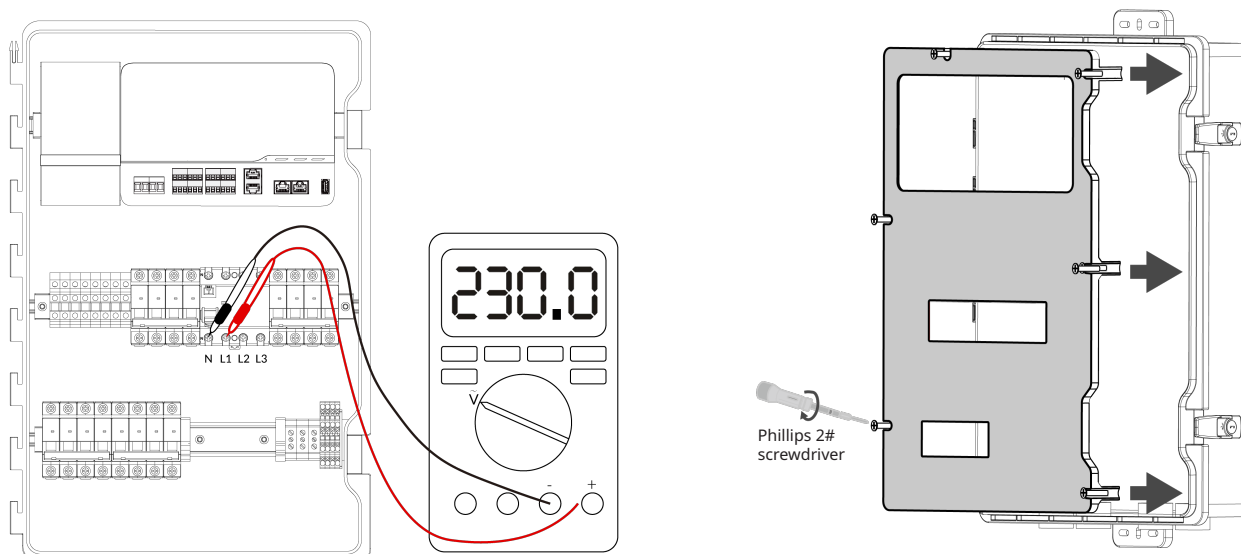

- c. If the voltage value is approximately the nominal phase voltage, e.g. 220 V, 230 V or 240 V, re-install the protective panel.
- d. Turn on the grid and the other breakers in the combiner. Then, the LED indicators on the MG100 will turn on.

4.7 Activate the System

- a. Log in to the Atmozen app on your mobile phone and follow the deployment guide in the app to activate the system. Details of the deployment guide can be found in the following section.
- b. After the system is activated, all LEDs will be solid green.

4.8 Lock the M-Combiner

- a. Close the door of the MC100-T and lock it by using the key in the package.

Deployment Guide

**Note**

- Ensure that your phone's operating system meets the following requirements: iOS 16.3.1 or later, or Android 11 or later.
- Complete the creation of the installer role following the registration process on the app.
- Before the configuration, confirm that all microinverters, gateways, batteries, and other loads have been installed and powered on.

5.1 Enter Site Details

- a. Log in to your installer account and tap + to create a site.
- b. Specify site details. Parameters marked with * are required

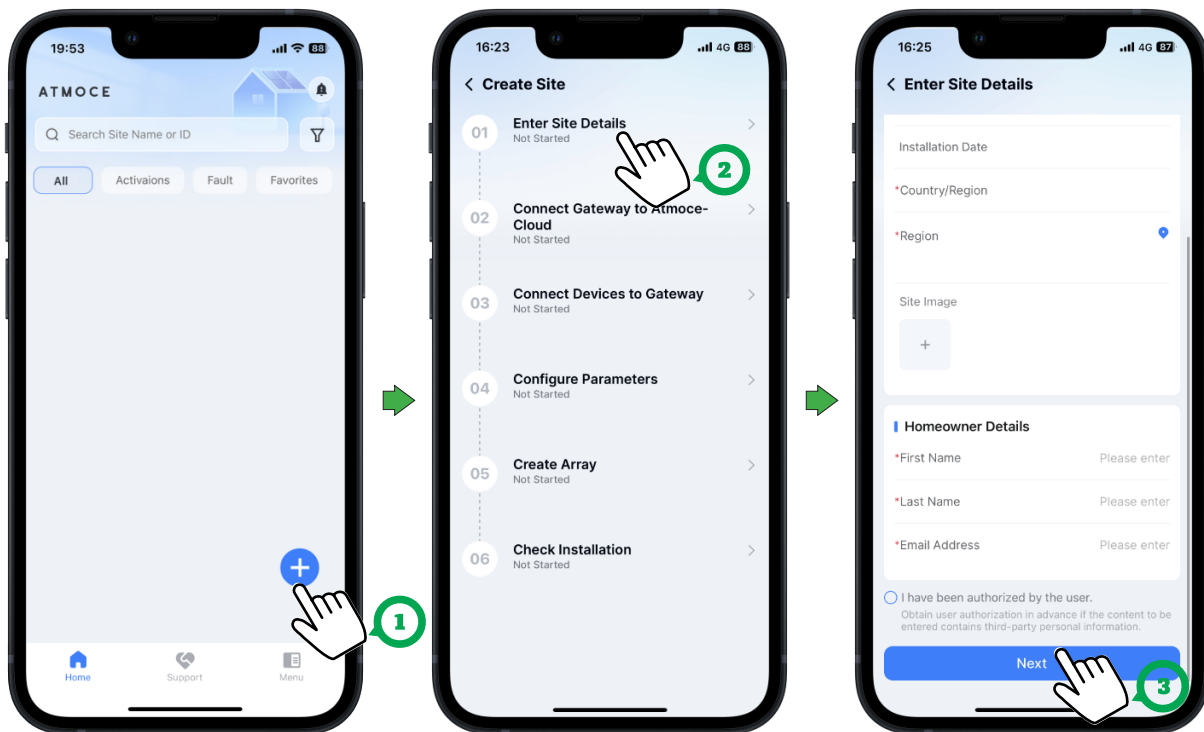

NOTE:

- Help the homeowner complete the registration process on the app, and specify the homeowner details based on the registered information.

5.2 Connect the Gateway to Atmoce-Cloud

- a. Enable Bluetooth on your phone, and keep your mobile phone close to the M-Gateway (<10 m).
- b. There are three methods to create a Bluetooth link:
 - **Nearby Device:** the default method. Check the Bluetooth device list, and select the SN number of the M-Gateway, whose name usually starts with "M".
 - **Scan to Add:** Scan the device serial number (QR code) on the M-Gateway.
 - **Add Manually:** Enter the device serial number of the M-Gateway.

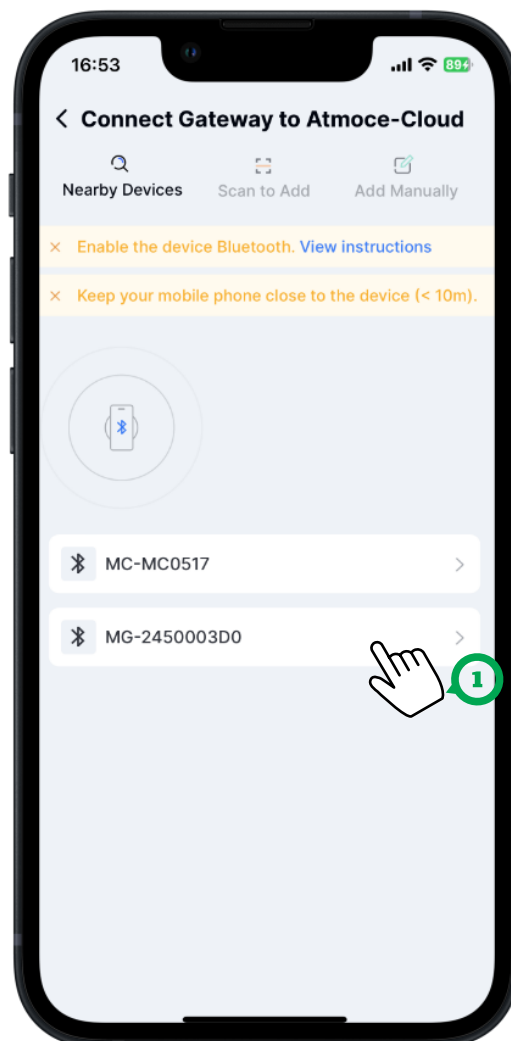

c. Configure a home network for your device and ensure proper network connection. There are two methods to create a connection:

- **Wi-Fi:** select **Wi-Fi Name** and input **Password**.
- **Ethernet:** connect the router to the combiner through a Cat 6 UTP ethernet cable. For more information, see Section 4.5.5 "(Optional) Wire from the Router."

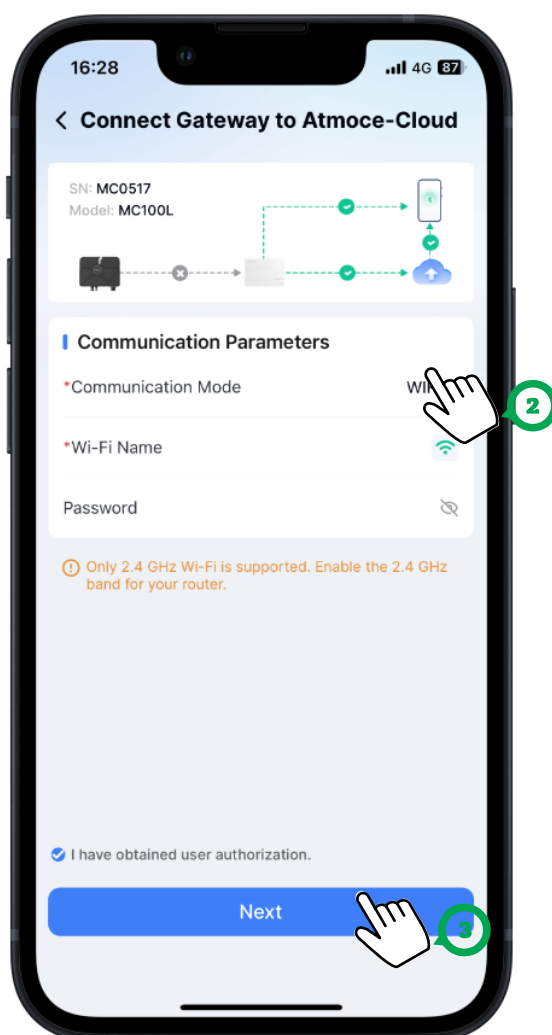

NOTE:

- The M-Gateway integrated Wi-Fi operates at 2.4 GHz and supports IPv4 and a number of wireless security protocols, including WPA-PSK and WPA2-PSK.
- The M-Gateway does not support Wi-Fi WPS.

5.3 Connect Devices to the Gateway

- a. The M-Gateway automatically searches for microinverters that are installed.
- b. Check the serial numbers of microinverters listed on the app against the installation map. If you find that not all devices are connected, you can tap **Detect Devices** to initiate a search again or tap **Add Manually** to add devices.

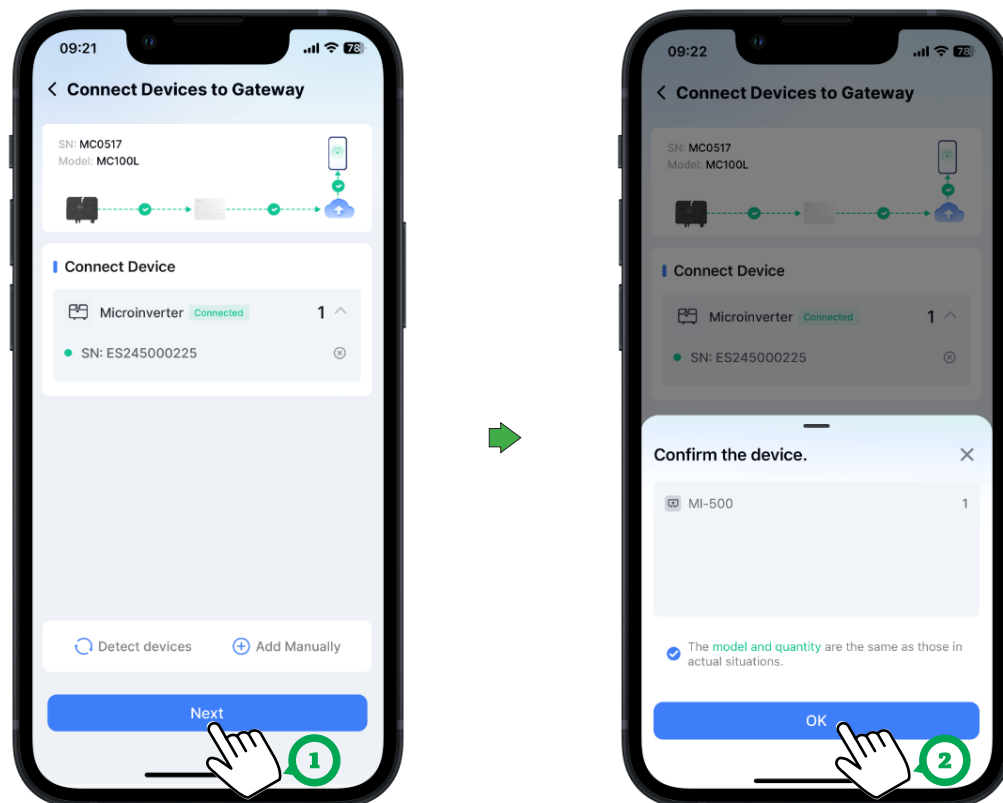

NOTE:

- If a device is deleted by mistake, it can be added again only by clicking **Add Manually**.

5.4 Configure Parameters

- a. Ensure that the settings of **Grid Profile** and **Time Zone** match the country or region where the site is located.

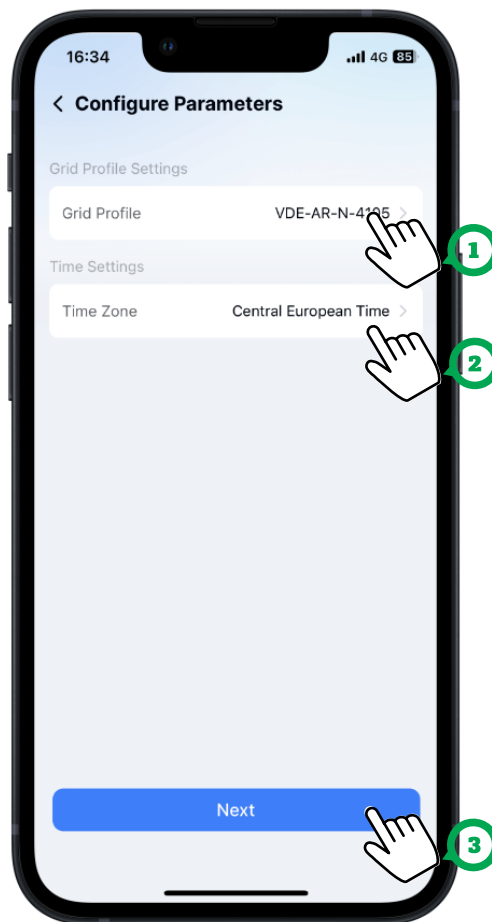

NOTE:

- If there is no grid profile that meets the local electricity authority requirements, please contact Atmoce Technical Support and request a new grid profile.

5.5 Create an Array

- Create the array diagram for module-level management.
- Please follow the steps shown below to complete the deployment of the array and the setting of the azimuth and tilt angle.

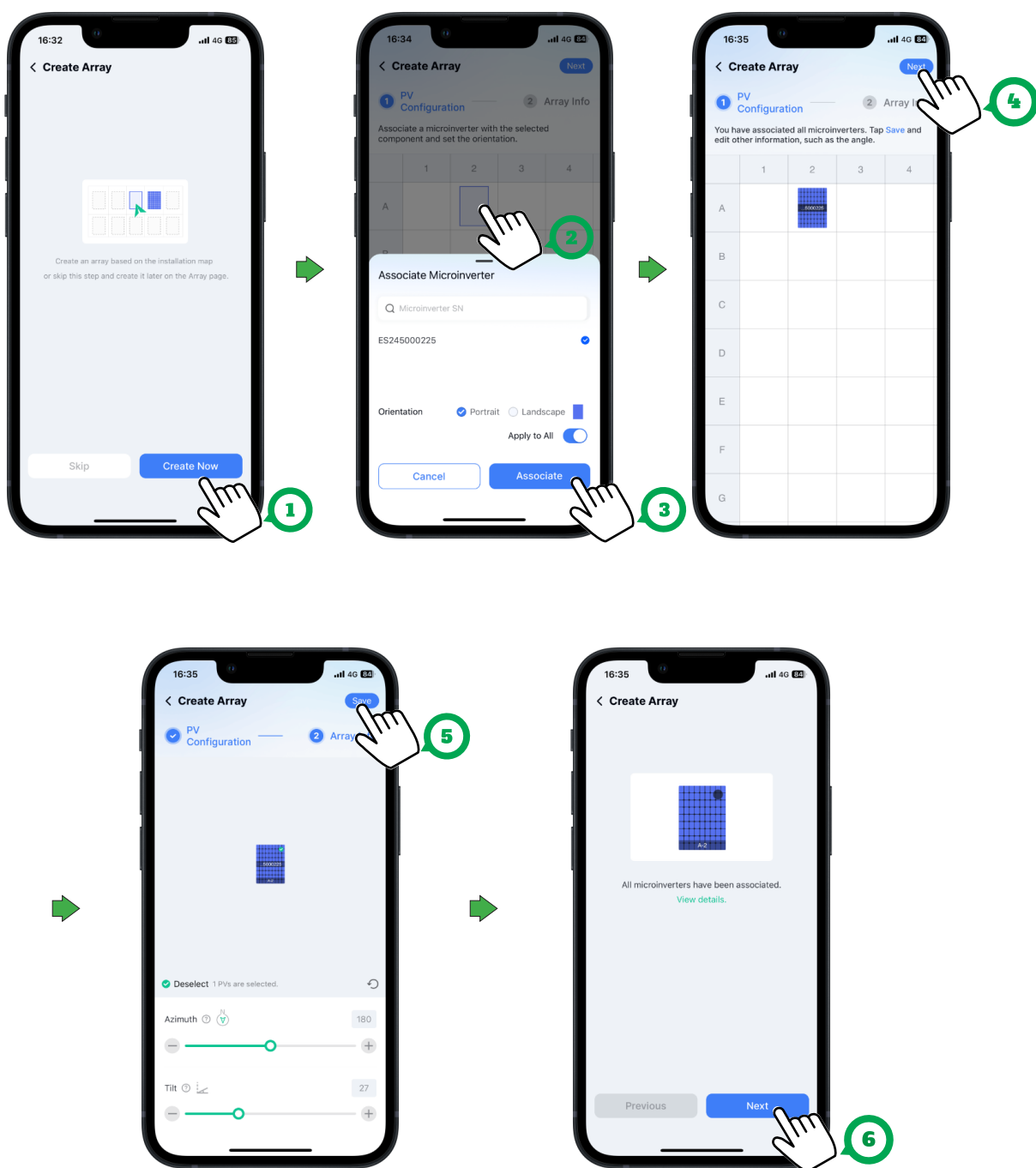

5.6 Check the Installation

- The system status is automatically diagnosed to ensure proper site runing. Ensure that all devices are in a normal state.
- Tap Complete Check to finish the activation.

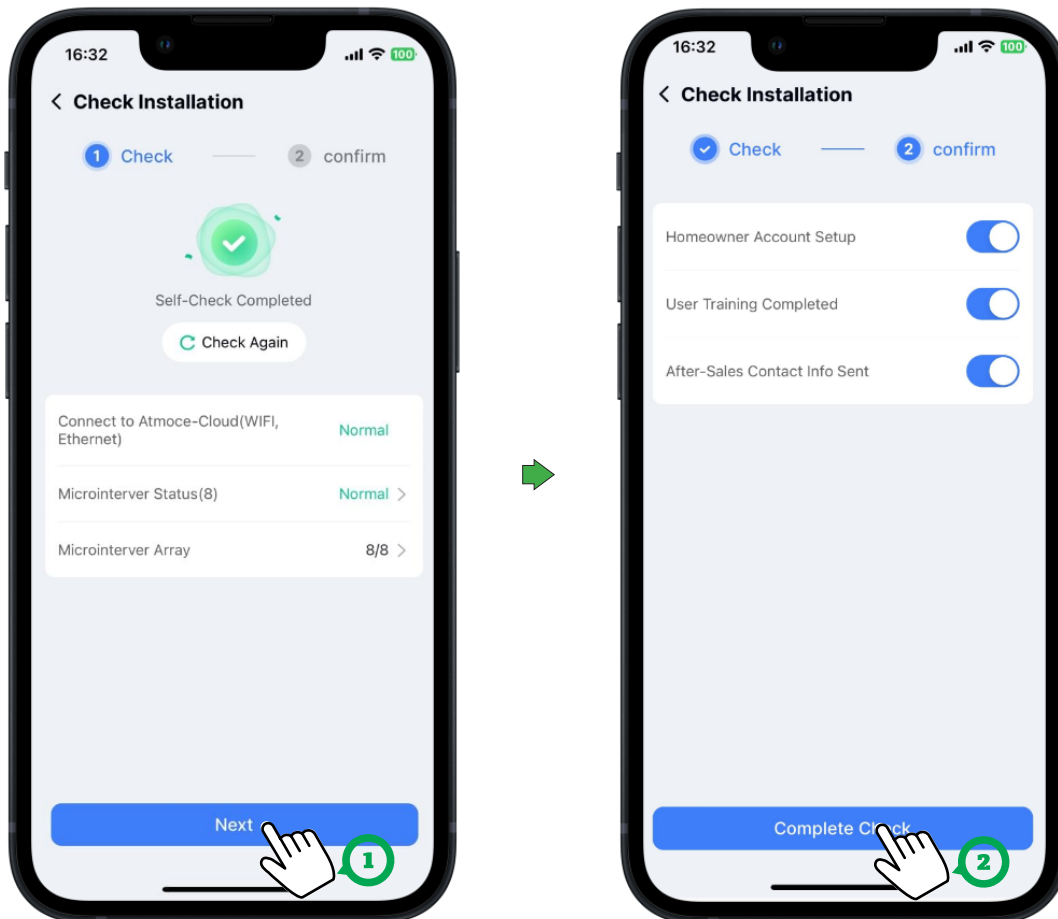

NOTE:









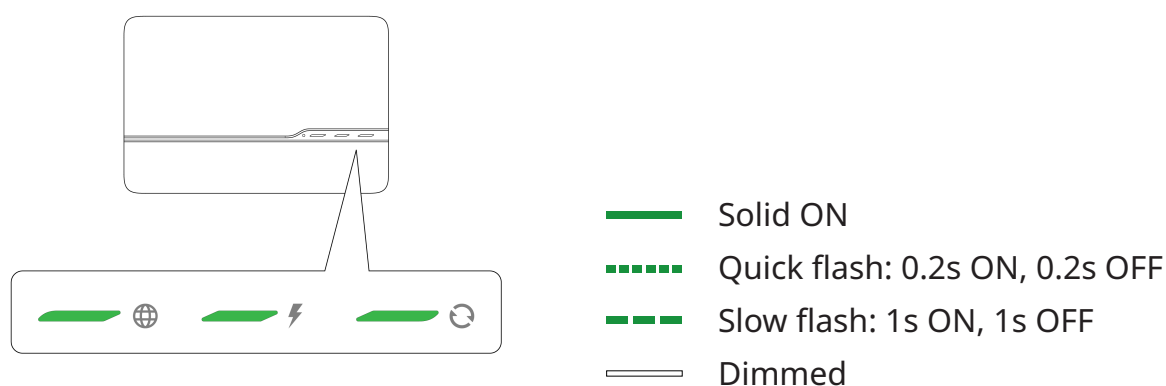





- Once the M-Gateway is connected to the Atmoce-Cloud, the network service is activated. The Atmoce-Cloud will support updates and upgrades for all connected devices in the future.

Troubleshooting

6.1 MG100 LED Indicator Description

- LED indicators can provide critical information on the operational status of devices. The status of LED indicators helps to solve related problems during on-site installation, configuration and troubleshooting.
- MG100 has three LED indicators, which are described as follows:





LED indicator	Colour		Description
 Network Status	Solid Green		Connecting to Atmoce-cloud.
	Quick Flash Green		Connecting to Atmozen app via Bluetooth.
	Slow Flash Red		No network available.
 Microinverter Power Status	Solid Green		All communicating microinverters are generating power.
	Slow Flash Orange		At least one microinverter is not generating power.
	Dimmed		All microinverters are not generating power.
 Microinverter Communication Status	Solid Green		All microinverters are communicating normally.
	Quick Flash Green		The MG100 is detecting microinverters.
	Slow Flash Orange		At least one microinverter is not communicating.
	Slow Flash Red		All microinverters are not communicating (not due to low light or night time).
	Dimmed		All microinverters are not communicating (due to low light or night time).
ALL	Slow Flash Green		Software update is in progress.

6.2 MG100 Reset Button

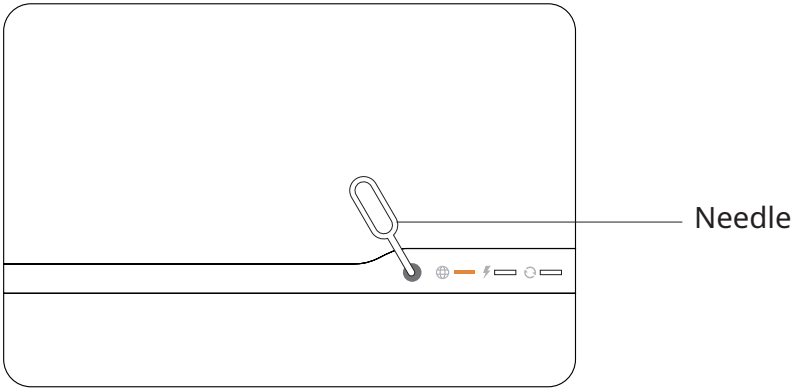
a. The MG100 has a reset button. The location of the button and the reset operation are shown as below.



	Function	Operation	Duration
1	Turn On Bluetooth		Press until the network indicator quickly flashes orange three times. 3s < Press < 10s
2	Turn Off Bluetooth		Press until the network indicator slowly flashes orange three times. 3s < Press < 10s
3	Restart the MG100		Step1: Press until all indicators are solid orange. Step2: Release the button. Step3: Press until all indicators are dimmed. 10s < Press < 20s 0s < Wait < 5s 10s < Press < 20s

6.3 MG100 Issue Troubleshooting

When an on-site problem occurs, the LED indicators on the MG100 can provide troubleshooting guidance. The following content will introduce common on-site problems and their solutions.

If you have any questions about the fault diagnosis, please contact Atmoce Technical Support (<https://www.atmoce.com/contact-us>).

6.3.1 If the network status LED is flashing red.

- Issue 1: The Wi-Fi communication is disconnected.

	Reason	Solution
1	The Wi-Fi name or password is incorrect.	<ul style="list-style-type: none"> • Reconfigure the Wi-Fi name and password through the Wi-Fi settings on the mobile app.
2	The Wi-Fi band is not 2.4GHz.	<ul style="list-style-type: none"> • Please contact your network service provider or check the router user manual for assistance. • Use a broadband router that supports the 2.4 GHz band.
3	The M-Combiner is outside the Wi-Fi coverage range	<ul style="list-style-type: none"> • Place the M-Combiner nearer to the router or add a wireless repeater to expand the Wi-Fi coverage range.
4	DHCP server issues.	<ul style="list-style-type: none"> • If the Dynamic Host Configuration Protocol (DHCP) server is disabled, enable it. • Confirm that you are using a broadband router, not a switch or hub. Many hubs and switches cannot provide a DHCP server and may not allow devices to connect to Ethernet or wireless networks.
5	Broadband router issues.	<ul style="list-style-type: none"> • If the SSID is hidden, turn off "Hide SSID". • Select "WPA-PSK" or "WPA2-PSK" for "Security Mode". • Select "AES" for "Encryption".
6	Unable to connect to the router.	<ul style="list-style-type: none"> • Check if other devices connected to the router are communicating properly. • Please contact your network service provider or check the router user manual for assistance.
7	The home broadband router has been replaced.	<ul style="list-style-type: none"> • Reconfigure the Wi-Fi name and password through the Wi-Fi settings on the mobile app.

- Issue 2: The ETH communication is disconnected.

	Reason	Solution
1	The Ethernet cable connection of the router is incorrect/unplugged.	<ul style="list-style-type: none"> • Replug the Ethernet cable. • Restart the router and MG100. If the problem persists, please replace the Ethernet cable.
2	DHCP server issues.	<ul style="list-style-type: none"> • If the DHCP server of the router is disabled, enable it. • Confirm that you are using a broadband router, not a switch or hub. Many hubs and switches cannot provide a DHCP server and may not allow devices to connect to Ethernet or wireless networks.
3	The broadband router has been replaced.	<ul style="list-style-type: none"> • Connect the Ethernet cable from the M-Combiner to the new router.

6.3.2 If the microinverter power status LED is dimmed.

- Issue 1: The system does not generate power.

	Reason	Solution
1	A grid error, such as an abnormal grid voltage or grid frequency, leads to system protection.	<ul style="list-style-type: none"> • Check the alert type in the app and resolve the alert based on the recommendations.
2	The alternating current cable is abnormal.	<ul style="list-style-type: none"> • Check whether the cables are connected properly in the combiner as indicated in the user manual. • Check whether the alternating current cables between the combiner and microinverters are connected properly.

3	Device protection is triggered in the combiner.	<ul style="list-style-type: none"> • Check whether each circuit breaker in the combiner is closed. • If there are some errors inside the device, contact your local installer.
4	A device fault occurred, for example, M-Relay protection in the grid.	<ul style="list-style-type: none"> • Check the alert type in the app and resolve the alert based on the recommendations.
5	Poor sunlight	<ul style="list-style-type: none"> • Wait until there is sufficient sunlight.

6.3.3 If the microinverter power status LED is flashing orange.

- Issue 1: One or more microinverters in the system do not generate power.

	Reason	Solution
1	The alternating current cable is abnormal.	<ul style="list-style-type: none"> • Check whether the cables are connected properly in the combiner as indicated in the user manual. • Check whether the alternating current cables between the combiner and microinverters are connected properly.
2	Device protection is triggered in the combiner.	<ul style="list-style-type: none"> • Check whether each circuit breaker in the combiner is closed. • If there are some errors inside the device, contact your local installer.
3	Active protection inside microverter is triggered due to abnormal solar voltage or grid voltage.	<ul style="list-style-type: none"> • Check the fault type in the app and resolve the fault based on the recommendations. • Contact your installer to replace the faulty microinverter.

6.3.4 If the microinverter communication status LED is flashing red.

- Issue 1: All microinverters communicates abnormally.

Reason	Solution
1 The alternating current cable is abnormal.	<ul style="list-style-type: none"> • Check whether the cables are connected properly in the combiner as indicated in the installation manual. • Check whether the alternating current cables between the combiner and microinverters are connected properly.
2 Device protection is triggered in the combiner.	<ul style="list-style-type: none"> • Check whether each circuit breaker in the combiner is closed. • If there are some errors inside the device, contact your local installer.
3 A device fault occurred, for example, M-Relay protection in the grid.	<ul style="list-style-type: none"> • Check the alert type in the app and resolve the alert based on the recommendations.
4 A gateway fault occurred.	<ul style="list-style-type: none"> • Try to turn off the grid breaker in the combiner or reset the gateway by referring to Section 6.2 "MG100 Reset Button." • If there are some errors inside the device, contact your local installer.

- Issue 2: All microinverters have internal faults.
 - a. Check whether the status of LED indicator on the microinverter is solid red. if so, disconnect the DC inputs from PV modules, wait for 5 to 10 minutes, and then reconnect the DC inputs.
 - b. If the LED indicator is still solid red, please contact Atmoce Technical Support.

6.3.5 If the microinverter communication status LED is flashing orange.

- Issue 1: Only one or scattered microinverters are not communicating.

	Reason	Solution
1	A connection fault occurs between the PV modules and the microinverters.	<ul style="list-style-type: none"> • Check whether the cables are connected properly in the combiner as indicated in the user manual. • Check whether the alternating current cables between the combiner and microinverters are connected properly.

2	The alternating current cable is abnormal.	<ul style="list-style-type: none"> • Check whether each circuit breaker in the combiner is closed. • If there are some errors inside the device, contact your local installer.

- Issue 2: The microinverter has an internal fault.

- Check the alerts in the Atmozen app to confirm which microinverter is in the faulty state.
- Disconnect the DC input of the faulty microinverter from the PV module, wait for 5 to 10 minutes, and then reconnect the DC input of the microinverter.
- If the LED indicator is still solid red, please contact Atmoce Technical Support.

6.3.6 If all the LEDs are dim

- Issue 1: The MG100 is not powered on.

	Reason	Solution
1	The MG100 is not powered on.	<ul style="list-style-type: none"> • Check that the grid circuit breaker is "on". • Check that the voltage of the L and N lines of the MG100 is within the voltage range (usually 184 Vac to 276 Vac).

2	Grid power outage occurred.	<ul style="list-style-type: none"> • Check whether the system generates power after grid recovery.

6.4 MR100 LED Indicator

LED indicator can provide critical information on the operational status of devices. The status of LED indicator helps to solve related problems during on-site installation, configuration and troubleshooting. The M-Relay MR100 has one LED indicator, which is described as follows:

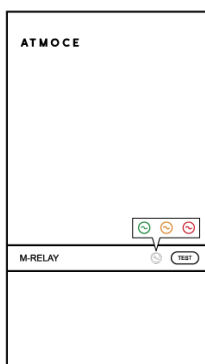

- Solid ON
- Quick flash: 0.2s ON, 0.2s OFF
- Slow flash: 1s ON, 1s OFF

Purpose	Colour		Description
1 Status	Solid Green		The M-Relay is working normally.
	Slow Flash Green		The M-Relay is waiting for upgrade or is being upgraded.
	Quick Flash Orange		The M-Relay is self-testing.
	Slow Flash Red		The M-Relay is in a faulty state.

6.5 MR100 Self-Test Button

The M-Relay has a self-test button. The location of the button and the reset operation are shown as below.

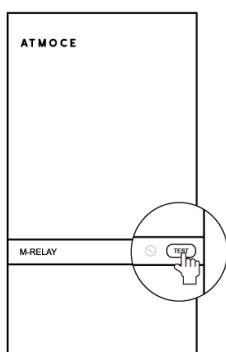

Purpose	Colour		Description
1 Self-Test	Flash Orange		Press twice within 3 seconds until the indicator flashes orange.

6.6 MR100 Issue Troubleshooting

When an on-site problem occurs, the LED indicator on the MR100 can provide troubleshooting guidance. The following content will introduce common on-site problems and their solutions.

If you have any questions about the fault diagnosis, please contact Atmoce Technical Support (<https://www.atmoce.com/contact-us>).

6.6.1 If the LED status LED is flashing red.

- Issue 1: The AC grid is abnormal.
 - a. Check the alert code in the Atmozen app and obtain the solution. The alert codes can be found in the "Alert Code List" section below.

- Issue 2: The internal circuit of the M-Relay failed.
 - a. Check the alert code in the Atmozen app and obtain the solution. The alert codes can be found in the "Alert Code List" section below.
 - b. Power off and then power on the generation system by using the breaker inside the M-Combiner. If the fault persists, contact your Distributor or Customer Service.

- Issue 3: The M-Relay is disconnected from the gateway.
 - a. Check the alert code in the Atmozen app and obtain the solution. The alert codes can be found in the "Alert Code List" section below.
 - b. Check whether the indicator of the M-Relay flashes in red or is off. If so, contact your Distributor or Customer Service.
 - c. Power off and then power on the gateway by using the grid breaker inside the M-Combiner. If the fault persists, contact your Distributor or Customer Service.

6.7 Check the Alert Codes

The device error codes can be viewed through the following steps in the Atmozen app:

- Tap **Status** of the site.
- Select the **faulty device** to check the details.

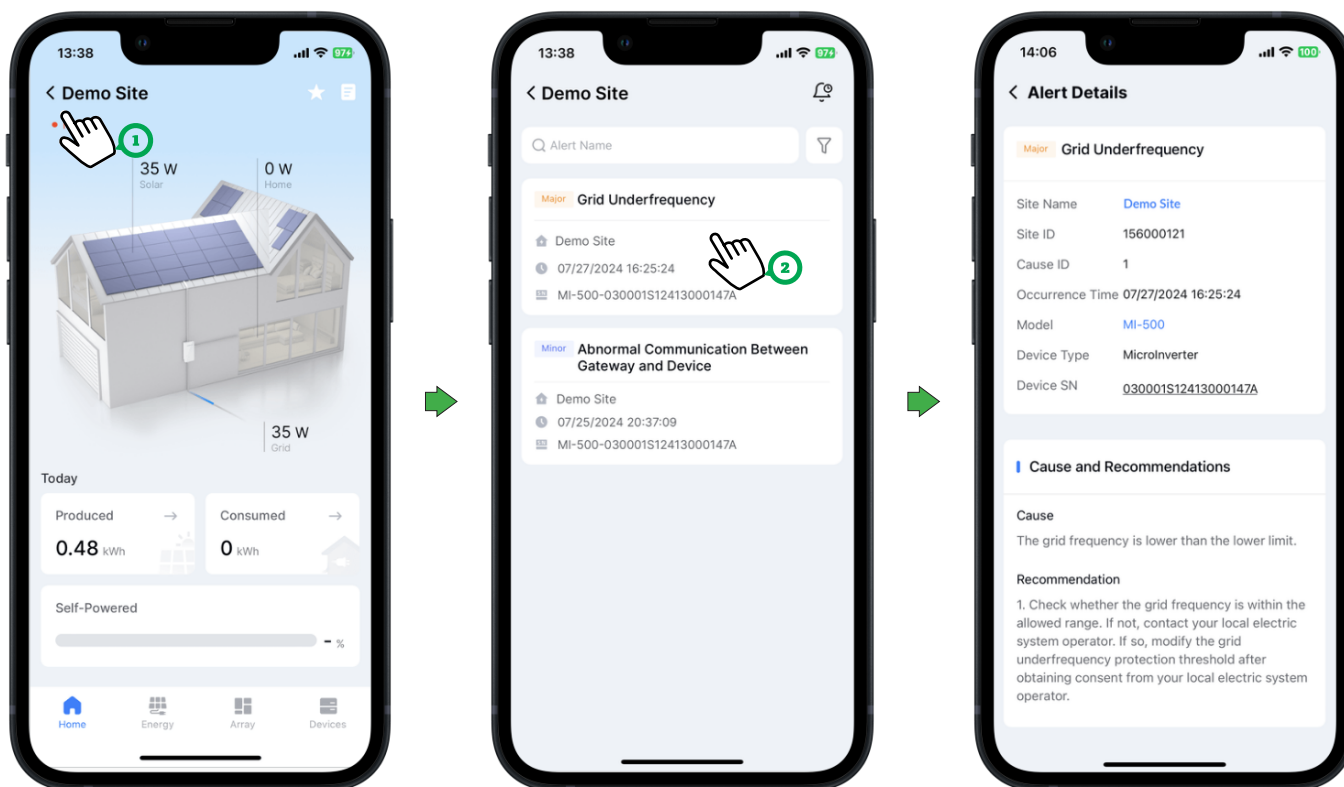

NOTE:

- The alert code check can be performed only after the system has been activated via the Atmozen app.
- Alert codes can be checked only when the site status is 'Faulty' or 'Offline'.

6.8 Alarm Codes List

The information about alerted issues of the Atmoce system can be found in the table below:

Code	Issue	Reason	Solution
1	High Direct Current Input Voltage	The open-circuit voltage of the PV module is set to a value higher than the maximum operating voltage of the device.	<ul style="list-style-type: none"> Check whether the open-circuit voltage of the PV module is higher than the maximum input voltage of the device specified in the user manual. If so, configure the PV module according to the user manual to ensure that the open-circuit voltage is within the allowed range. Then, the alert will be automatically cleared.
2	Grid Power Outage	Grid power outage occurred.	<ul style="list-style-type: none"> Check whether the grid is normally powered. Check whether the alternating current cable or switch is disconnected.
3	Grid Undervoltage	The grid voltage is lower than the lower limit.	<ul style="list-style-type: none"> Check whether the grid voltage is within the allowed range. If not, contact your local electric system operator. If so, modify the grid undervoltage protection threshold after obtaining consent from your local electric system operator. If the fault persists, check whether the alternating current switch and cable are connected properly.
4	Grid Overvoltage	The grid voltage is higher than the upper limit.	<ul style="list-style-type: none"> Check whether the grid voltage is within the allowed range. If not, contact your local electric system operator. If so, modify the grid overvoltage protection threshold after obtaining consent from your local electric system operator. If the fault persists, check whether the alternating current breaker and cable are connected properly, or whether the cable complies with the recommended specifications.
5	Grid Underfrequency	The grid frequency is lower than the lower limit.	<ul style="list-style-type: none"> Check whether the grid frequency is within the allowed range. If not, contact your local electric system operator. If so, modify the grid underfrequency protection threshold after obtaining consent from your local electric system operator.

Code	Issue	Reason	Solution
6	Grid Overfrequency	The grid frequency is higher than the upper limit.	<ul style="list-style-type: none"> Check whether the grid frequency is within the allowed range. If not, contact your local electric system operator. If so, modify the grid overfrequency protection threshold after obtaining consent from your local electric system operator.
7	High Output Direct Current Component	The output direct current component is higher than the upper limit.	<ul style="list-style-type: none"> The device automatically manages external working conditions in real time and returns to normal after the fault is resolved. If the fault occurs frequently, contact your Distributor or Customer Service.
8	Low Direct Current-Side Insulation Resistance	The insulation between the PV module and the ground is poor.	<ul style="list-style-type: none"> Check the insulation between the PV module and the ground. If there is a short circuit or poor insulation, rectify it.
9	Internal Device Error	The internal circuit of the microinverter failed.	<ul style="list-style-type: none"> Wait for the inverter to power on again until the next day. If the fault persists, contact your Distributor or Customer Service.
		The internal circuit of the gateway failed.	<ul style="list-style-type: none"> Power off and then repower the gateway by using the grid breaker inside the M-Combiner. If the fault persists, contact your Distributor or Customer Service.
		The internal circuit of the M-Relay failed.	<ul style="list-style-type: none"> Power off and then repower the generation system by using the breaker inside the M-Combiner. If the fault persists, contact your Distributor or Customer Service.
		The M-Relay is disconnected from the gateway.	<ul style="list-style-type: none"> Check whether the indicator of the M-Relay flashes in red or is off. If so, contact your Distributor or Customer Service. Power off and then repower the gateway by using the grid breaker inside the M-Combiner. If the fault persists, contact your Distributor or Customer Service.
10	Active Device Protection	The operating environment of the inverter is abnormal.	<ul style="list-style-type: none"> The device automatically checks external working conditions and returns to normal after the fault is resolved. If the alert is reported frequently, contact your Distributor or Customer Service.

Code	Issue	Reason	Solution
256	Abnormal Communication Between Gateway and Device	<ul style="list-style-type: none"> The device is shut down. The AC cable between the microinverter and gateway is abnormal. 	<ul style="list-style-type: none"> Check whether the AC switch is disconnected. If the AC switch is disconnected, close the AC switch. Wait for the inverter to be powered on again the next day and confirm the communication status. If the fault still exists, check whether the AC line is disconnected and whether the AC wiring and mating terminals are abnormal.
257	Abnormal Communication Between Gateway and Atmoce-Cloud	<ul style="list-style-type: none"> The gateway is shut down. The gateway network is improperly configured. The network between the gateway and Atmoce-Cloud is abnormal. 	<ul style="list-style-type: none"> Observe the indicator of the gateway to check whether it is shut down. Check whether the router is connected to the Internet. If the gateway is connected to the Internet via Wi-Fi: <ol style="list-style-type: none"> Check whether the Wi-Fi name and password are changed. Check whether Wi-Fi signals are strong. If the gateway is connected to the Internet via a network cable: <ol style="list-style-type: none"> Check whether the router network and cable are normal. DHCP mode: Check whether DHCP mode is enabled for the router. Manual mode: Check whether the IP address, gateway, and DNS are properly configured for the router.
258	Upgrade Failure	<ul style="list-style-type: none"> Microinverter upgrade failed. M-Relay upgrade failed. Gateway upgrade failed. 	<ul style="list-style-type: none"> Try to upgrade again. If the fault persists, contact your Distributor or Customer Service.

Maintenance

7.1 Remove MC100-T

If, after the above troubleshooting, the M-Combiner still does not operate normally, please contact Atmoce Technical Support. If the warranty conditions are met, the M-Combiner can be removed and replaced.

The removal procedure is as follows:

- a. Disconnect the main circuit breaker in the distribution panel.
- b. Open the door of the MC100-T and turn off all the breakers in the combiner.
- c. Remove the protective panel of the MC100-T.
- d. Remove the power and communication cables from the breakers and terminal blocks in the MC100-T.
- e. Unscrew the screws for that fasten the mounting tabs and remove the MC100-T from the wall.
- f. Reinstall the protective panel and close the door.

7.2 Replace MC100-T

If, after the above troubleshooting, the M-Combiner still does not operate normally, please contact Atmoce Technical Support. If the warranty conditions are met, the M-Combiner can be removed and replaced.

The replacement procedure is as follows:

- Remove the MC100-T (refer to the "Remove MC100-T" section).
- Secure the replaced MC100-T to the wall (refer to the "Installation" section).
- Turn on the circuit breakers in the distribution panel and MC100-T.
- Retrieve the serial number of the removed combiner from the device list in the Atmozen app and replace the device. Specifically, perform the following steps:
 - Tap Menu – Devices.
 - Select the replaced device to check the details.
 - Tap Replacement – Enter the SN of new device.

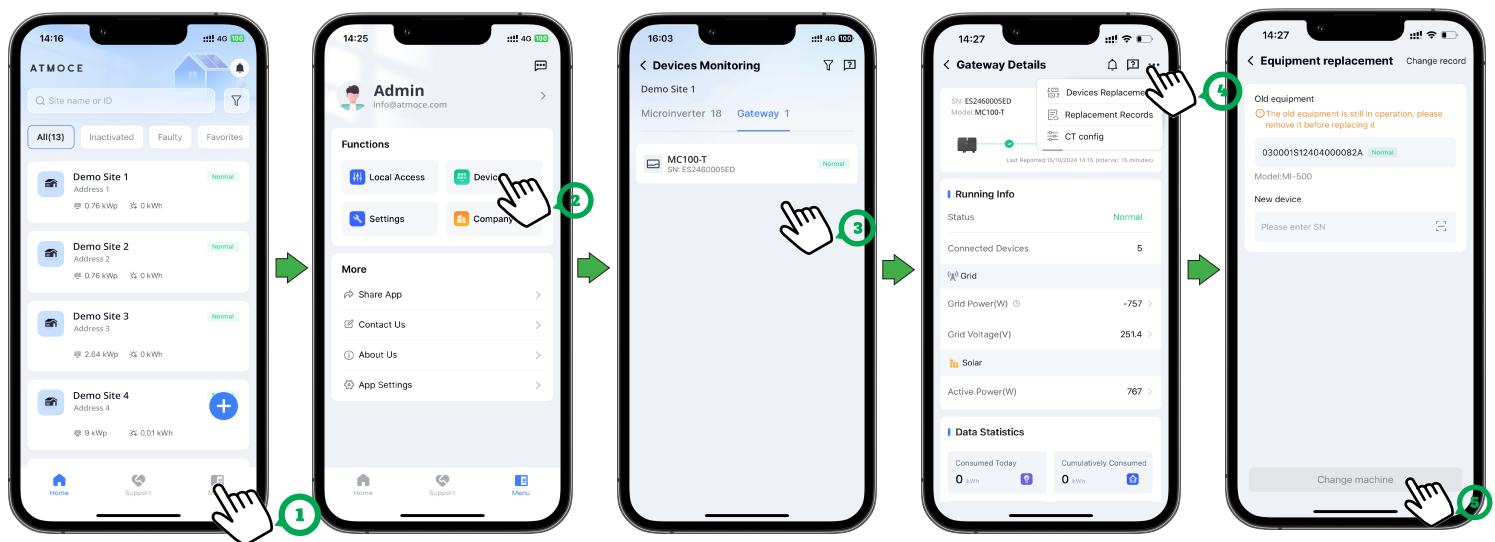

- Check the operating status and the device information of the device in the Atmozen app to confirm that the new combiner is operating normally.

NOTE:

- If both the MC100-T and the microinverter need to be replaced, the MC100-T must be replaced first.

Technical Data

8.1 MC100-T Data Sheet

Items	Unit	MC100-T
What's in the combiner		
M-Gateway MG100		1 × MG100
SPD		1 × unit, In: 20 kA, 4-pole
PV-side breaker ^a		2 × units, 20 A, 4-pole
Grid-side breaker		1 × unit, 63 A, 4-pole, RCD 30mA
Battery-side breaker		1 × unit, 63 A, 4-pole
Microinverter CT		3 × CTs, accurate up to 0.1%
Battery CT		3 × CTs, accurate up to 0.1%
Consumption CT interface		1 × CT signal interface, accurate up to 0.1%
M-Relay MR100-T		1 × unit, 50 A, 4-pole
Electrical parameters		
Grid setup		Three-phase
Nominal voltage	V	220/380 Va.c., 230/400 Va.c., 3(N)~
Nominal operating voltage range (L to N)	V	184 to 276
Nominal frequency	Hz	50/60
Extended frequency range	Hz	45 to 65
Max. PV branch		2
Max. PV current/branch	A	20
Max. battery current	A	63
Max. battery capacity	kWh	42
Nominal CT current	A	80
Overvoltage category		III
Mechanical parameters		
Dimensions (W x H x D)	mm	389 × 616 × 127
Weight	kg	8.6
Ambient temperature range	°C	-30 to 50
Cooling		Natural convection
Enclosure environmental rating		Outdoor, IP65
Wire sizes	mm ²	PV side: 2.5 to 4 Grid side: 10 to 16 Battery side: 10 to 16

Item	Unit	MC100-T
Communication cable sizes	mm ²	0.25-0.75
Communication		PLC, Wi-Fi, BLE, ETH, CAN, RS485
Noise	dB	<25
Altitude	m	3000
Protection class		II
Pollution degree		III

Communication interfaces		

PV side	PLC	Support
Grid side		1 × interface for consumption CT
Battery side	CAN	Support
Load side	ETH	1 × interface, 100 Mb/10 Mb auto-adaptability
	Digital I/O	4 × 12 V DO, 3 × DI
	RS485	Support
Atmoce-Cloud	Wi-Fi	2.4 GHz
	ETH	1 × interface, 100 Mb/10 Mb auto-adaptability
Atmozen app	BLE	2.4 GHz
Indicators		3 × LEDs

Compliance		

Safety		IEC 61439-1/-2
Health		EN IEC 62311
EMC		EN 301 489-1/-17, EN IEC 61000-1/-2/-3/-4
Radio spectrum		EN 300 328
PLC		EN 50065-1/-2

8.2 MG100 Data Sheet

Items	Unit	MG100	
Electrical parameters			
Grid setup		Single-phase	Three-phase
Nominal voltage	V	220/230/240	220/380 Va.c., 230/400 Va.c., 3(N)~
Nominal operating voltage range (L to N)	V	184 to 276	
Nominal frequency	Hz	50/60	
Extended frequency range	Hz	45 to 65	
Power consumption	W	<5 (without USB device) < 20 (with USB device)	
Overvoltage category		III	
AC surge protection		TYPE II	
Mechanical parameters			
Dimensions (W x H x D)	mm	221 × 148 × 42	
Weight	kg	0.6	
Ambient temperature range	°C	-30 to 65	
Cooling		Natural convection	
Enclosure environmental rating		IP30	
Communication		PLC, Wi-Fi, BLE, ETH, CAN, RS485	
Noise	dB	<25	
Altitude	m	3000	
Protection class		II	
Pollution degree		II	
Communication interfaces			
PV side	PLC	Support	
	Microinverter CT	1 × CT interface	3 × CT interfaces
Grid side	Consumption CT	1 × CT interface	
Battery side	CAN	Support	
	Battery CT	1 × CT interface	3 × CT interfaces
Load side	ETH	1 × interface, 100 Mb/10 Mb auto-adaptability	
	Digital I/O	4 × 12V DO, 3 × DI	
	RS485	Support	
M-Relay	RS485	Support	
Atmoce-Cloud	Wi-Fi	2.4 GHz	
	ETH	1 × interface, 100 Mb/10 Mb auto-adaptability	
Atmozen app	BLE	2.4 GHz	
Indicators		3 × LEDs	

Item	Unit	MG100
Compliance		
Safety		IEC 61439-1/-2
Health		EN IEC 62311
EMC		EN 301 489-1/-17, EN IEC 61000-1/-2/-3/-4
Radio spectrum		EN 300 328
PLC		EN 50065-1/-2

8.3 M-Relay Data Sheet

Item	Unit	MR100
Electrical parameters		
System phase setup		
Nominal voltage	V	220/380 Va.c., 230/400 Va.c., 3(N)~
Nominal operating voltage range (L to N)	V	184 to 276
Nominal frequency	Hz	50/60
Extended frequency range	Hz	45 to 65
Max. continuous current	A	40/phase
Night power consumption	W	<1
Overvoltage Category		III
AC surge protection		TYPE II
Mechanical parameters		
Dimensions (W x H x D)	mm	85 × 148 × 40
Weight	kg	0.4
Ambient temperature range	°C	-30 to 65
Cooling		Natural convection
Enclosure environmental rating		IP20
Noise	dB	<25
Altitude	m	3000
Protection class		II
Pollution degree		II
Communication interfaces		
M-Gateway		RS485
Indicators		1 × LED
Compliance		
Safety		EN 60255
Health		EN IEC 62311
EMC		EN 301 489-1/-17, EN IEC 61000-1/-2/-3/-4

Appendix 1: System Schematic Diagram

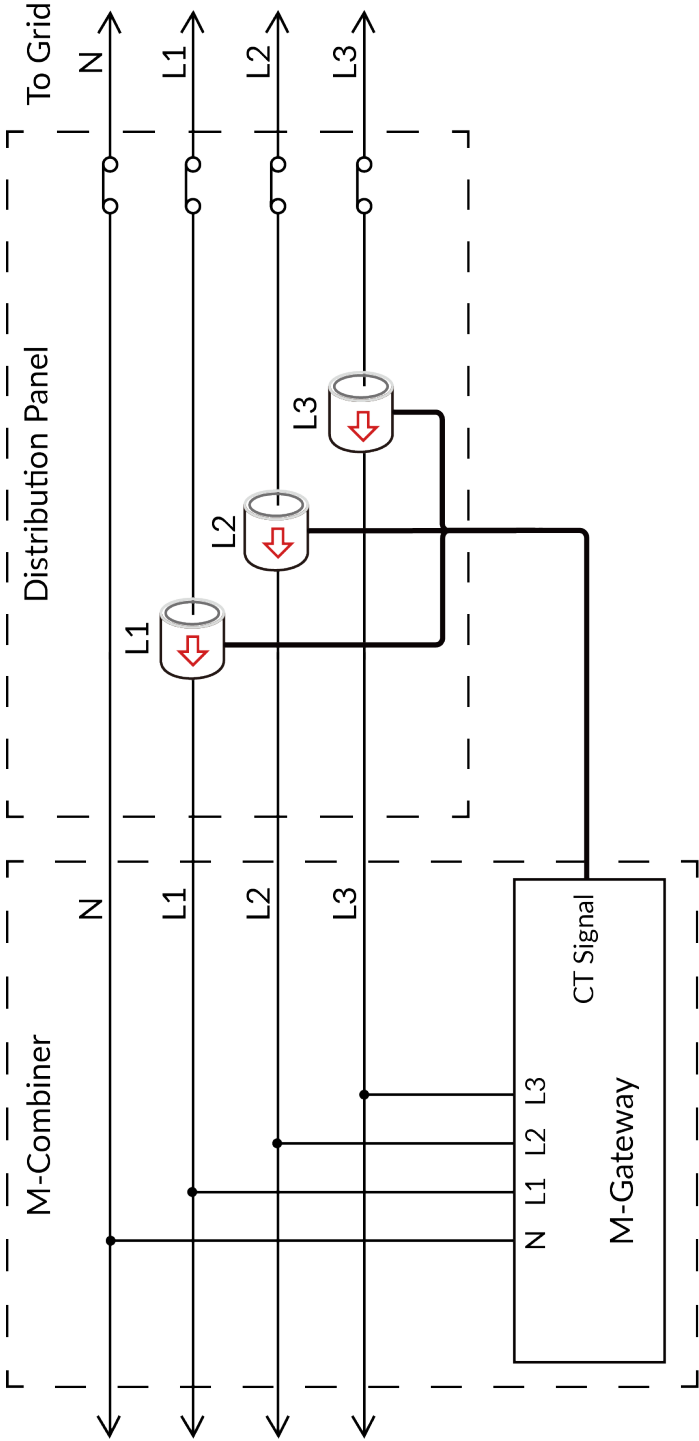

Appendix 2: Wire Diagram

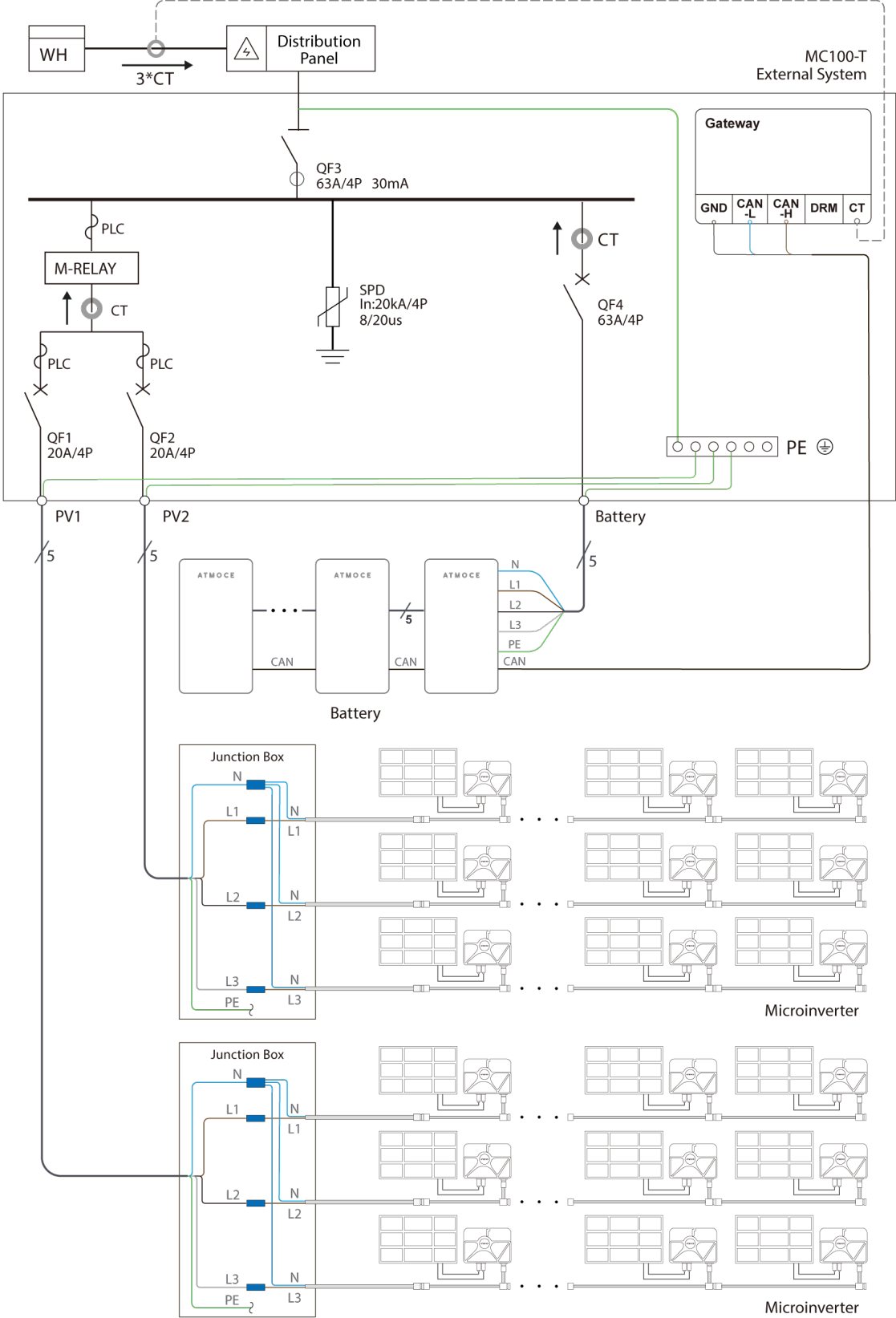

Appendix 3: Terms and Abbreviations

AC	Alternating current
APP	Application
CAT 6	Category 6
DC	Direct current
DI	Digital input
DO	Digital output
EMC	Electromagnetic Compatibility
ETH	Ethernet
MPPT	Maximum power point tracking
PE	Protective earthing
PV	Photovoltaic
RH	Relative humidity
SN	Serial number
WEEE	Waste electrical and electronic equipment

Contact Us

Company: Atmoce Holding B.V.
Address: Singel 250, 1016AB Amsterdam, Netherlands.
Email: info@atmoce.com
Telephone: +31 6 39877352