

TRI-STAND mounting system

For pitched roofs, flat roofs and fronts

TRI-STAND – The mounting system

The development of the new mounting system TRI-STAND is based on well-founded know-how and years of practical experience. The knowledge gained from the implementation of numerous solar systems resulted in a mounting system that is ideally suited for all applications – from small stand-alone systems to large grid-connected systems, on pitched and flat roofs as well as fronts.

Insertion profile TS – The aluminium profile

The insertion profile TS of the TRI-STAND mounting system allows the easy, quick and thus efficient installation of all popular framed solar modules. After the insertion of the modules into the aluminium profile, the modules are held in place by their own weight and friction. The photovoltaic modules do not need to be screwed in.

Universal profiles UP / UP-L / UP-S – The base profiles

The universal profiles UP, UP-L and UP-S are the basic profiles of the TRI-STAND mounting system. The universal profile UP is used for standard systems. For appli-

cations with low static stresses the universal profile UP-L is used, however for great static stresses UP-S. The revolutionary design of the universal profiles allows for two types of installation: the easy to install insertion system with cross bracing and the insertion profile TS or the cost-effective clip system with middle and end clips. – The choice is yours.

SafeClick SC – The secure connector

SafeClicks connect the universal profiles of the TRI-STAND mounting system securely and easily with its insertion profiles. The practical design of the SafeClick allows easy installation by simply clicking in the insertion profiles. Drilling is not necessary.

Middle rail TS-M – The optimal reinforcement

In the case of vertical module insertion and acceptance of pressures of more than 2400 N/m², some module manufacturers specify the use of a middle support. The TRI-STAND middle rail TS-M is specifically designed for the mounting system and the ideal support for all popular modules.























Insertion of modules into the cross bracing of profiles – the stable and installation-friendly version for pitched roofs.



The upright installation represents the more flexible and installation-friendly version for flat roofs, which can compensate for any unevenness.

MOUNTING SYSTEMS – COMPONENTS On-the-Roof System

Art. No.	1502622	1502199	1502694	1502200	1502800
					
Model	TRI-STAND insertion profile TS-31, 6.000 m, blank aluminium	TRI-STAND insertion profile TS-34, 6.000 m, blank aluminium	TRI-STAND insertion profile TS-35, 3.000 m, blank aluminium	TRI-STAND insertion profile TS-35, 6.000 m, blank aluminium	TRI-STAND insertion profile TS-38, 3.000 m, blank aluminium
Application	Pitched roof, flat roof and building exterior	Pitched roof, flat roof and building exterior	Pitched roof, flat roof and building exterior	Pitched roof, flat roof and building exterior	Pitched roof, flat roof and building exterior
Frame thickness	31 mm	34 mm	35 mm	35 mm	38 mm
Dimensions (L / W / H)	6000 mm / 54 mm / 47 mm	6000 mm / 54 mm / 50 mm	3000 mm / 54 mm / 51 mm	6000 mm / 54 mm / 51 mm	6000 mm / 54 mm / 54 mm
Weight *	1.195 kg	1.107 kg	1.115 kg	1.115 kg	1.139 kg
Norms	IEC 61215 ed. 2 (10.16), TÜV	IEC 61215 ed. 2 (10.16), TÜV	IEC 61215 ed. 2 (10.16), TÜV	IEC 61215 ed. 2 (10.16), TÜV	IEC 61215 ed. 2 (10.16), TÜV
Art. No.	1502798	1502695	1502201	1502696	1502202
					
Model	TRI-STAND insertion profile TS-38, 6.000 m, blank aluminium	TRI-STAND insertion profile TS-40, 3.000 m, blank aluminium	TRI-STAND insertion profile TS-40, 6.000 m, blank aluminium	TRI-STAND insertion profile TS-42, 3.000 m, blank aluminium	TRI-STAND insertion profile TS-42, 6.000 m, blank aluminium
Application	Pitched roof, flat roof and building exterior	Pitched roof, flat roof and building exterior	Pitched roof, flat roof and building exterior	Pitched roof, flat roof and building exterior	Pitched roof, flat roof and building exterior
Frame thickness	38 mm	40 mm	40 mm	42 mm	42 mm
Dimensions (L / W / H)	6000 mm / 54 mm / 54 mm	3000 mm / 54 mm / 56 mm	6000 mm / 54 mm / 56 mm	3000 mm / 54 mm / 58 mm	6000 mm / 54 mm / 58 mm
Weight *	1.139 kg	1.155 kg	1.155 kg	1.172 kg	1.172 kg
Norms	IEC 61215 ed. 2 (10.16), TÜV	IEC 61215 ed. 2 (10.16), TÜV	IEC 61215 ed. 2 (10.16), TÜV	IEC 61215 ed. 2 (10.16), TÜV	IEC 61215 ed. 2 (10.16), TÜV
Art. No.	1502697	1502661	1502699	1502203	1502700
					
Model	TRI-STAND insertion profile TS-45, 3.000 m, blank aluminium	TRI-STAND insertion profile TS-45, 6.000 m, blank aluminium	TRI-STAND insertion profile TS-46, 3.000 m, blank aluminium	TRI-STAND insertion profile TS-46, 6.000 m, blank aluminium	TRI-STAND insertion profile TS-50, 3.000 m, blank aluminium
Application	Pitched roof, flat roof and building exterior	Pitched roof, flat roof and building exterior	Pitched roof, flat roof and building exterior	Pitched roof, flat roof and building exterior	Pitched roof, flat roof and building exterior
Frame thickness	45 mm	45 mm	46 mm	46 mm	50 mm
Dimensions (L / W / H)	3000 mm / 54 mm / 61 mm	6000 mm / 54 mm / 61 mm	3000 mm / 54 mm / 62 mm	6000 mm / 54 mm / 62 mm	6000 mm / 54 mm / 66 mm
Weight *	1.196 kg	1.196 kg	1.204 kg	1.204 kg	1.236 kg
Norms	IEC 61215 ed. 2 (10.16), TÜV	IEC 61215 ed. 2 (10.16), TÜV	IEC 61215 ed. 2 (10.16), TÜV	IEC 61215 ed. 2 (10.16), TÜV	IEC 61215 ed. 2 (10.16), TÜV
Art. No.	1502204	1502707	1502212	1502708	1502653
					
Model	TRI-STAND insertion profile TS-50, 6.000 m, blank aluminium	TRI-STAND universal profile UP, 3.000 m, blank aluminium	TRI-STAND universal profile UP, 6.000 m, blank aluminium	TRI-STAND universal profile UP-L, 3.000 m, blank aluminium	TRI-STAND universal profile UP-L, 6.000 m, blank aluminium
Application	Pitched roof, flat roof and building exterior	Pitched roof, flat roof and building exterior	Pitched roof, flat roof and building exterior	Pitched roof, flat roof and building exterior	Pitched roof, flat roof and building exterior
Frame thickness	50 mm	Any	Any	Any	Any
Dimensions (L / W / H)	6000 mm / 54 mm / 66 mm	3000 mm / 40 mm / 41 mm	6000 mm / 40 mm / 41 mm	3000 mm / 40 mm / 41 mm	6000 mm / 40 mm / 41 mm
Weight *	1.236 kg	1.344 kg	1.344 kg	0.976 kg	0.976 kg
Norms	IEC 61215 ed. 2 (10.16), TÜV	IEC 61215 ed. 2 (10.16), TÜV	IEC 61215 ed. 2 (10.16), TÜV	IEC 61215 ed. 2 (10.16), TÜV	IEC 61215 ed. 2 (10.16), TÜV

Continued on next page

On-the-Roof System MOUNTING SYSTEMS – COMPONENTS

Art. No. 1502824 1502711 1502213 1502715 1502680



Model	TRI-STAND universal profile UP-L, 6.200 m, blank aluminium	TRI-STAND universal profile UP-S, 3.000 m, blank aluminium	TRI-STAND universal profile UP-S, 6.000 m, blank aluminium	TRI-STAND universal profile UP-TS, 3.000 m, blank aluminium	TRI-STAND universal profile UP-TS, 6.000 m, blank aluminium
Application	Pitched roof, flat roof and building exterior	Pitched roof, flat roof and building exterior	Pitched roof, flat roof and building exterior	Pitched roof, flat roof and building exterior	Pitched roof, flat roof and building exterior
Frame thickness	Any	Any	Any	Any	Any
Dimensions (L / W / H)	6200 mm / 40 mm / 41 mm	3000 mm / 70 mm / 41 mm	6000 mm / 70 mm / 41 mm	3000 mm / 54 mm / 41 mm	6000 mm / 54 mm / 41 mm
Weight *	0.976 kg	1.585 kg	1.585 kg	1.216 kg	1.216 kg
Norms	IEC 61215 ed. 2 (10.16), TÜV	IEC 61215 ed. 2 (10.16), TÜV	IEC 61215 ed. 2 (10.16), TÜV	IEC 61215 ed. 2 (10.16), TÜV	IEC 61215 ed. 2 (10.16), TÜV

Art. No. 1502714 1502211 1502623 1502205 1502702



Model	TRI-STAND middle rail TS-M, 3.000 m, blank aluminium	TRI-STAND middle rail TS-M, 6.000 m, blank aluminium	TRI-STAND insertion profile TS-31, 6.000 m, black	TRI-STAND insertion profile TS-34, 6.000 m, black	TRI-STAND insertion profile TS-35, 3.000 m, black
Application	Pitched roof, flat roof and building exterior	Pitched roof, flat roof and building exterior	Pitched roof, flat roof and building exterior	Pitched roof, flat roof and building exterior	Pitched roof, flat roof and building exterior
Frame thickness	Any	Any	31 mm	34 mm	35 mm
Dimensions (L / W / H)	3000 mm / 85 mm / 17 mm	6000 mm / 85 mm / 17 mm	6000 mm / 54 mm / 47 mm	6000 mm / 54 mm / 50 mm	3000 mm / 54 mm / 51 mm
Weight *	0.775 kg	0.775 kg	1.195 kg	1.107 kg	1.115 kg
Norms	IEC 61215 ed. 2 (10.16), TÜV	IEC 61215 ed. 2 (10.16), TÜV	IEC 61215 ed. 2 (10.16), TÜV	IEC 61215 ed. 2 (10.16), TÜV	IEC 61215 ed. 2 (10.16), TÜV

Art. No. 1502206 1502801 1502799 1502703 1502207



Model	TRI-STAND insertion profile TS-35, 6.000 m, black	TRI-STAND insertion profile TS-38, 3.000 m, black	TRI-STAND insertion profile TS-38, 6.000 m, black	TRI-STAND insertion profile TS-40, 3.000 m, black	TRI-STAND insertion profile TS-40, 6.000 m, black
Application	Pitched roof, flat roof and building exterior	Pitched roof, flat roof and building exterior	Pitched roof, flat roof and building exterior	Pitched roof, flat roof and building exterior	Pitched roof, flat roof and building exterior
Frame thickness	35 mm	38 mm	38 mm	40 mm	40 mm
Dimensions (L / W / H)	6000 mm / 54 mm / 51 mm	3000 mm / 54 mm / 54 mm	6000 mm / 54 mm / 54 mm	3000 mm / 54 mm / 56 mm	6000 mm / 54 mm / 56 mm
Weight *	1.115 kg	1.139 kg	1.139 kg	1.155 kg	1.155 kg
Norms	IEC 61215 ed. 2 (10.16), TÜV	IEC 61215 ed. 2 (10.16), TÜV	IEC 61215 ed. 2 (10.16), TÜV	IEC 61215 ed. 2 (10.16), TÜV	IEC 61215 ed. 2 (10.16), TÜV

Art. No. 1502704 1502208 1502705 1502209 1502706









Model	TRI-STAND insertion profile TS-42, 3.000 m, black	TRI-STAND insertion profile TS-42, 6.000 m, black	TRI-STAND insertion profile TS-46, 3.000 m, black	TRI-STAND insertion profile TS-46, 6.000 m, black	TRI-STAND insertion profile TS-50, 3.000 m, black
Application	Pitched roof, flat roof and building exterior	Pitched roof, flat roof and building exterior	Pitched roof, flat roof and building exterior	Pitched roof, flat roof and building exterior	Pitched roof, flat roof and building exterior
Frame thickness	42 mm	42 mm	46 mm	46 mm	50 mm
Dimensions (L / W / H)	3000 mm / 54 mm / 58 mm	6000 mm / 54 mm / 58 mm	3000 mm / 54 mm / 62 mm	6000 mm / 54 mm / 62 mm	3000 mm / 54 mm / 66 mm
Weight *	1.172 kg	1.172 kg	1.204 kg	1.204 kg	1.236 kg
Norms	IEC 61215 ed. 2 (10.16), TÜV	IEC 61215 ed. 2 (10.16), TÜV	IEC 61215 ed. 2 (10.16), TÜV	IEC 61215 ed. 2 (10.16), TÜV	IEC 61215 ed. 2 (10.16), TÜV

Continued on next page



MOUNTING SYSTEMS – COMPONENTS On-the-Roof System

Art. No.	1502210	1502712	1502415	1502713	1502654
					
Model	TRI-STAND insertion profile TS-50, 6.000 m, black	TRI-STAND universal profile UP, 3.000 m, black	TRI-STAND universal profile UP, 6.000 m, black	TRI-STAND universal profile UP-L, 3.000 m, black	TRI-STAND universal profile UP-L, 6.000 m, black
Application	Pitched roof, flat roof and building exterior	Pitched roof, flat roof and building exterior	Pitched roof, flat roof and building exterior	Pitched roof, flat roof and building exterior	Pitched roof, flat roof and building exterior
Frame thickness	50 mm	Any	Any	Any	Any
Dimensions (L / W / H)	6000 mm / 54 mm / 66 mm	3000 mm / 40 mm / 41 mm	6000 mm / 40 mm / 41 mm	3000 mm / 40 mm / 41 mm	6000 mm / 40 mm / 41 mm
Weight *	1.236 kg	1.344 kg	1.344 kg	0.976 kg	0.976 kg
Norms	IEC 61215 ed. 2 (10.16), TÜV	IEC 61215 ed. 2 (10.16), TÜV	IEC 61215 ed. 2 (10.16), TÜV	IEC 61215 ed. 2 (10.16), TÜV	IEC 61215 ed. 2 (10.16), TÜV

Art. No.	1502416	1502739	1502740	1502414
				
Model	TRI-STAND universal profile UP-S, 6.000 m, black	TRI-STAND universal profile UP-TS, 6.000 m, black	TRI-STAND middle rail TS-M, 3.000 m, black	TRI-STAND middle rail TS-M, 6.000 m, black
Application	Pitched roof, flat roof and building exterior	Pitched roof, flat roof and building exterior	Pitched roof, flat roof and building exterior	Pitched roof, flat roof and building exterior
Frame thickness	Any	Any	Any	Any
Dimensions (L / W / H)	6000 mm / 70 mm / 41 mm	6000 mm / 54 mm / 41 mm	3000 mm / 85 mm / 17 mm	6000 mm / 85 mm / 17 mm
Weight *	1.585 kg	1.216 kg	0.775 kg	0.775 kg
Norms	IEC 61215 ed. 2 (10.16), TÜV	IEC 61215 ed. 2 (10.16), TÜV	IEC 61215 ed. 2 (10.16), TÜV	IEC 61215 ed. 2 (10.16), TÜV

* - Per meter

Accessories

Art. No.	1502214	1502307	1502215	1502436	1502216
					
Model	TRI-STAND end bracket TS-E, blank aluminium	TRI-STAND end bracket TS-E, black	TRI-STAND SafeClick SC	TRI-STAND special SafeClick, with 7 mm drill hole	TRI-STAND insertion profile connector TS-C
Application	Pitched and flat roof	Pitched and flat roof	Pitched and flat roof	Pitched roof	Pitched and flat roof
Dimensions (L / W / H)	32 mm / 29 mm / 33 mm	32 mm / 29 mm / 33 mm	13 mm / 45 mm / 70 mm	13 mm / 45 mm / 70 mm	95 mm / 64 mm / 17 mm
Weight	0.010 kg	0.010 kg	0.050 kg	0.050 kg	0.080 kg

Art. No.	1502217	1502218	1502219	1502222	1502223
					
Model	TRI-STAND universal profile connector UP-C	TRI-STAND slide nut M8	TRI-STAND slide nut M10	TRI-STAND FlexFix (20 - 70°)	TRI-STAND Z adapter UP-Z
Application	Pitched and flat roof	Pitched and flat roof	Pitched and flat roof	Flat roof	Pitched and flat roof
Dimensions (L / W / H)	120 mm / 51 mm / 41 mm	32 mm / 21 mm / 9 mm	32 mm / 21 mm / 9 mm	65 mm / 40 mm / 35 mm	102 mm / 30 mm / 34 mm
Weight	0.130 kg	0.010 kg	0.010 kg	0.150 kg	0.200 kg

Continued on next page

On-the-Roof System MOUNTING SYSTEMS – COMPONENTS

Art. No. 1502224 1502410 1502225 1502226 1502227



Model	TRI-STAND spacer UP-D, 3 mm	TRI-STAND spacer UP-D, 6 mm	TRI-STAND middle clip (31 - 40 mm), blank aluminium	TRI-STAND middle clip (41 - 50 mm), blank aluminium	TRI-STAND middle clip (31 - 40 mm), black
Application	Pitched and flat roof	Pitched and flat roof	Pitched and flat roof	Pitched and flat roof	Pitched and flat roof
Dimensions (L / W / H)	56 mm / 35 mm / 3 mm	56 mm / 35 mm / 6 mm	70 mm / 35 mm / 27 mm	70 mm / 35 mm / 27 mm	70 mm / 35 mm / 27 mm
Weight	0.050 kg	0.100 kg	0.100 kg	0.100 kg	0.100 kg

Art. No. 1502228 1502632 1502229 1502230 1502233



Model	TRI-STAND middle clip (41 - 50 mm), black	TRI-STAND end clip 31 mm, blank aluminium	TRI-STAND end clip 34 mm, blank aluminium	TRI-STAND end clip 35 mm, blank aluminium	TRI-STAND end clip 40 mm, blank aluminium
Application	Pitched and flat roof	Pitched and flat roof	Pitched and flat roof	Pitched and flat roof	Pitched and flat roof
Dimensions (L / W / H)	70 mm / 35 mm / 27 mm	50 mm / 31 mm / 27 mm	50 mm / 34 mm / 27 mm	50 mm / 35 mm / 27 mm	50 mm / 40 mm / 27 mm
Weight	0.100 kg	0.040 kg	0.040 kg	0.040 kg	0.040 kg

Art. No. 1502234 1502665 1502235 1502236



Model	TRI-STAND end clip 42 mm, blank aluminium	TRI-STAND end clip 45 mm, blank aluminium	TRI-STAND end clip 46 mm, blank aluminium	TRI-STAND end clip 50 mm, blank aluminium
Application	Pitched and flat roof	Pitched and flat roof	Pitched and flat roof	Pitched and flat roof
Dimensions (L / W / H)	50 mm / 42 mm / 27 mm	50 mm / 45 mm / 27 mm	50 mm / 46 mm / 27 mm	50 mm / 50 mm / 27 mm
Weight	0.040 kg	0.040 kg	0.040 kg	0.040 kg

Art. No. 1502633 1502237 1502238 1502241

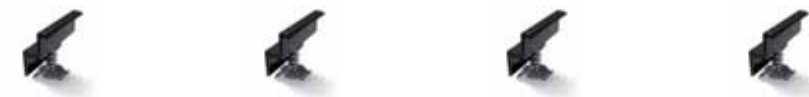

Model	TRI-STAND end clip 31 mm, black	TRI-STAND end clip 34 mm, black	TRI-STAND end clip 35 mm, black	TRI-STAND end clip 40 mm, black
Application	Pitched and flat roof	Pitched and flat roof	Pitched and flat roof	Pitched and flat roof
Dimensions (L / W / H)	50 mm / 31 mm / 27 mm	50 mm / 34 mm / 27 mm	50 mm / 35 mm / 27 mm	50 mm / 40 mm / 27 mm
Weight	0.040 kg	0.040 kg	0.040 kg	0.040 kg

Art. No. 1502242 1502243 1502244 1502777



Model	TRI-STAND end clip 42 mm, black	TRI-STAND end clip 46 mm, black	TRI-STAND end clip 50 mm, black	TRI-STAND bending tool
Application	Pitched and flat roof	Pitched and flat roof	Pitched and flat roof	Pitched and flat roof
Dimensions (L / W / H)	50 mm / 42 mm / 27 mm	50 mm / 46 mm / 27 mm	50 mm / 50 mm / 27 mm	292 mm / 18 mm / 6 mm
Weight	0.040 kg	0.040 kg	0.040 kg	0.231 kg

Continued on next page



MOUNTING SYSTEMS – COMPONENTS On-the-Roof System

Art. No.	1302257	1302258	1502245	1502246
				
Model	TRI-STAND grounding clamp for insertion profile TS	TRI-STAND grounding clamp for connector TS-C	TRI-STAND cross cable clip block UP-K	TRI-STAND edge clip TS-EC
Application	Pitched and flat roof	Pitched and flat roof	Pitched and flat roof	Pitched and flat roof
Dimensions (L / W / H)	16 mm / 10 mm / 13 mm	21 mm / 10 mm / 13 mm	22 mm / 22 mm / 16 mm	18 mm / 15 mm / 11 mm
Weight	0.002 kg	0.002 kg	0.002 kg	0.001 kg

TRI-STAND has successfully passed the TÜV tests. Patent applications have been filed for SafeClick and FlexFix.

Other TRI-STAND profile types upon request.

For the insertion system, please comply with the module manufacturer's instructions.